

Internet Radio

IR-135

User Manual

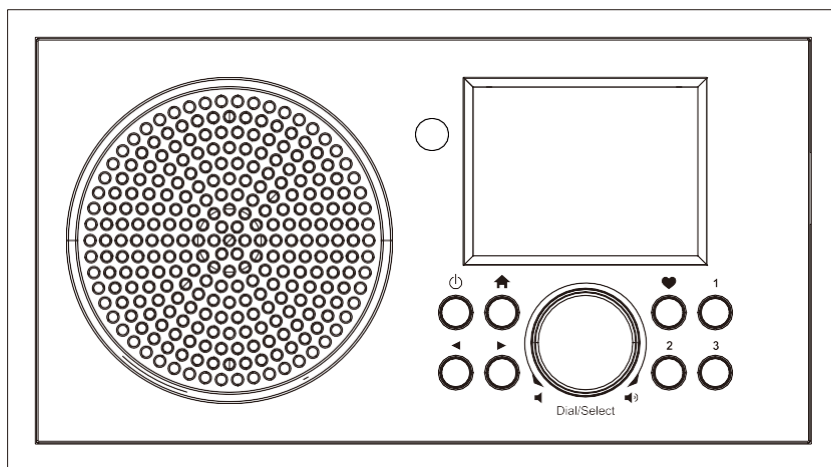

Please read this user manual carefully before using the receiver

Location of Controls	1
How to input password for your wireless network	2
1. Getting started	4
2. Charging battery	4
3. Network Setup	5
4. Overview of features and functions	6
5. Internet Radio	7
6. Media Centre	9
7. Bluetooth playback.....	10
8. Alarm Setting	11
9. Sleep Timer Setting	12
10. Configuration	13
11. Remote control via PC / Smart phone	
- Tuning internet radio & manage favourite	18
12. Trouble Shooting.....	21
Helpful Tips.....	23
Technical Specification	24
In the box.....	25

Location of Controls

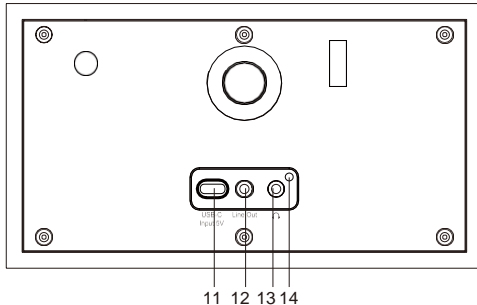
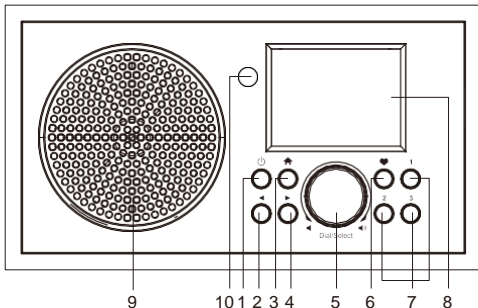

Press and hold to power on/off

Press and release to Standby / activate the radio (Standby is enabled only when power is connected. It will be disabled when battery power is used)



Back to previous menu/left pointer



Return to Home screen / Return to the playing screen



Right pointer/Enter edit menu of the Favourite list /Display the big time clock & radio info on the now playing screen

5. Dial / Select / Volume

Rotate to scroll along, up/down on the menu / Select menu options

Push to confirm / push to stop / resume playback of radio channel

Rotate to adjust the volume level



Press and hold to preset a particular station

Press to recall the favourite list

7. Preset button 1-3

Preset the top three favourite stations

Press and hold to preset

Press it briefly to recall

8. TFT color screen 2.4"

9. Speaker

10. Infrared sensor

11. USB port to connect USB-C cable for charging built-in battery

12. Line output jack 3.5 mm

13. Earphone jack 3.5 mm

14. LED indicator for battery charging status

How to input password for your wireless network

Using control button on the radio unit

Use the **[Tune/Select]** knob to scroll through the characters, highlight it and press **[Tune/Select]** button to confirm and input the next character. When it comes to the last character of the password, press and hold **[Tune/Select]** to confirm and complete the entry.

Note: The password is case sensitive.

Please ensure the following is ready:

You have a broadband internet connection.

A wireless broadband router is connected to the internet successfully. The radio supports Wireless B, G and N connection (Wireless N router can also be used with the setting on B or G). You know the Wired Equivalent Privacy (WEP) or Wi-Fi Protected Access (WPA) data encryption code/password. You need to key in the correct code when the radio is connected to the wireless router for network connection. If you do not know the code/password, please contact the person/technician who set up the router/network for you.

The radio works via Wireless network connection (Wi-Fi connection).

Precautions

The radio should not be used in a high temperature or high humidity environment over prolonged periods of time as this may damage the unit.

Keep the radio away from liquids as it may get damaged. Please switch off the radio immediately if water or liquids is spilled into the radio. Consult with the shop you bought this radio for any question.

Avoid using or storing the unit in dusty or sandy environment. Do not open and repair the radio by yourself.

Clean only with dry cloth.



1. Getting started

The radio is powered by the built-in lithium battery. A USB cable is supplied in the product package.

Press and hold the [] button to power on.

To power off the radio, press and hold the same button.

The Standby mode is enabled only when the power is connected and so to make use of the Alarm clock function.

Connect the power supply to the radio, press and hold the [] button to turn it on. Pressing the [] button again will turn the radio into standby.

2. Charging battery

You can check the level of battery power remains on the radio.

There is a battery power indicator  showing on the top row of the screen.

When battery power is low, the battery indicator keeps blinking as a reminder for battery charging.

To charge the battery, connect the USB-C plug to the port where located at the rear side of the radio, connect the other end to a power source supplied in 5V OUT (the rating of the electric current is minimum 1A or higher), The LED on the rear side of the radio will light up in red indicates the battery is charging. The charging icon  will appear on the screen.

When charging is done, the LED on the rear side will turn to green and the icon on screen will change to  . it means the radio has the power connected.

Note: The charging might take much longer to complete if the radio is playing while charging.

3. Network Setup

Internet connection is setup via Wireless network (WiFi).
Your radio requires a broadband Internet connection.

- If this is first time use, the Configure Network wizard will be displayed. Choose Yes to start configuring network. Press the [◀] button or turn the [Tune/Select] knob to highlight Yes and press [Tune/Select] to confirm.

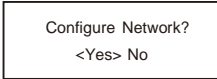

- Select Add/Remove AP from the list, use the [Tune/Select] knob to scroll and press it to confirm, then choose Add AP (Scan):

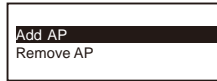
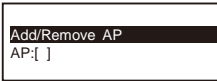

- It will start scanning the Wi-Fi networks available. Scroll to your network and press the [Tune/Select] to confirm. If your wifi network has a password protected, it will ask you to enter the passphrase/password. Please refer to the above section '**How to input password for your wireless network**' on P.3.

Note: The password is case sensitive. Please consult with the one who setup your network if you don't know the password.

- When the Wi-Fi connection is successful, the Association Complete will be shown briefly. The wifi signal bar will appear on the top left corner of the display:

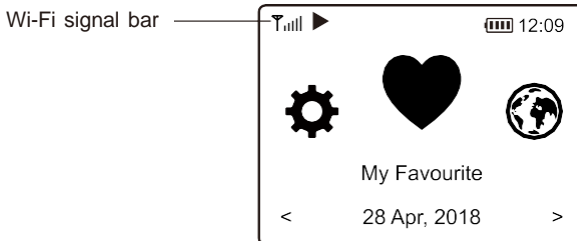

4. Overview of features and functions

Press [] to enter the Home screen. Scroll by rotating the [Tune/Select] knob:

My Favorite - To show the list of favorite stations which have been assigned to the presets. There are up to 99 presets available.

Internet Radio - Start exploring the worldwide radio stations and music here.

Media Centre - Browse and stream music from your network via UPnP or DLNA Compatible devices.

Bluetooth - Bluetooth playback, to play audio stream (receive) from another Bluetooth enabled device after pairing/connected each other.

Alarm - Alarm clock. Two alarm settings available. (It works only when the power is connected and standby is enabled)

Sleep Timer - Enable the timer to turn the radio off after the selected time elapsed.

Configuration - More options/settings available to personalize as you desire.

On the Home screen, choose **Internet Radio** and you will find the options below:



Skytune

Select Skytune to start enjoying thousands of radio stations over the world. You can filter your search by Region, Music genre and talks.

The **Local Radio** let you access quickly the stations available in your local area through internet connection.



Note - You can change the Local Radio area under **Configuration> Local radio setup**. Please refer to section 10 for the details.

Search

Instead of browsing the radio station list, you can input a few characters of the desired station to filter out / short list the stations.

History

The radio memorizes the stations you have listened up to 99 stations.

If you have listened more than 99 stations, it will supersede the first station that you have listened.

Start playing internet radio

When the screen shows the state of radio playback, more radio information can be displayed. Press the ► button in the state of the playing screen below:

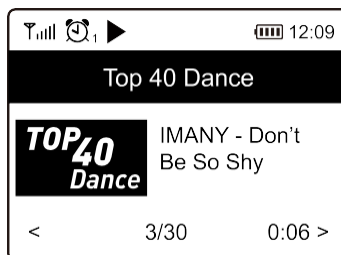

5. Internet Radio

Every time you press the ► button, it will cycle through the information of the radio, the big time clock and the radio station logo if any.

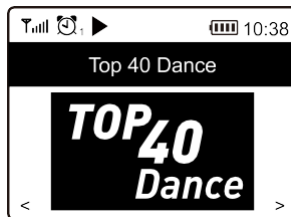
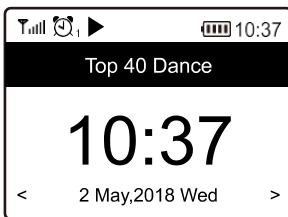
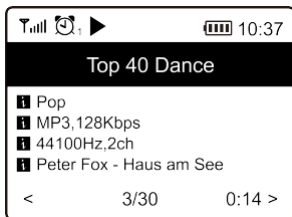

My Favorite

This is to show the list of your Favorite stations which have been assigned to the presets.

Preset a station

In the state of playing screen, press and hold the ♥ on the unit, you will see the icon appeared [⬇] as below. It means the station is added to the Favorite list.

Preset icon

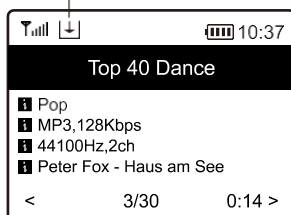

The new added station will always show in the last item on the Favorite list. You can store up to 99 presets.

Recall a station

Press the ♥ briefly on the radio unit to recall the list of presets, or navigate to **My Favourite** on the Home screen and select it to confirm.

Edit your favorite list

On the Favorite list, choose the radio station you want to edit then press [►] on the unit. It will enter the Edit menu with the following options:

Move down - To move down the ranking of a station

Move up - To move up the ranking of a station

Delete - To delete a particular station

Move to top - To move the station to the top of the favorite list.

Move to bottom - To move the station to the bottom of the favorite list.

The device supports UPnP and is DLNA-compatible.

This provides the opportunity to stream music from your network. However, this requires you to have a compatible device in your network that can function as a server. This can be e.g., a network hard drive or a conventional PC with e.g., Windows 8 via which access to the shared folder or media sharing is permitted. The folders can then be browsed and played on the radio.

Note - Please make sure your computer laptop is on the same Wi-Fi network as the Radio before you start using this function.

Music streaming

- Once the UPnP/DLNA compatible server is configured to share media files with your radio, you can start music streaming.
- On the main menu, select **Media Centre and choose UPnP**.
- It may take a few seconds for the radio to complete the scan for available UPnP servers. If no UPnP servers are found, it will show **Empty List**.
- After a successful scan is done, select your UPnP server.
- The radio will show the media categories available from the UPnP server, e.g. 'Music', 'Playlists' etc.
- Choose the media files that you wish to play.

You can set the mode of playback under **Configuration > Playback setup**.

My Playlist

You can make your own playlist for the UPnP music files. Choose and highlight the song you want to add to playlist, press and hold the **[Tune/Select]** knob, until the sign  appears. The song will be added to **My playlist**.

Clear My Playlist

Remove all songs in "My Playlist" to allow a new playlist to be prepared.

Note - If you have DLNA compatible servers available, follow the steps described above to browse the audio files from DLNA compatible device on the radio to play.

7. Bluetooth playback

Before transmission between your Bluetooth device and the radio is possible, both devices must be coupled. This process is called "pairing". The radio is served as a receiver, to receive music stream to play on the radio.

If you have already coupled to a Bluetooth device before, this connection will be restored automatically when both devices are in range and Bluetooth operation has been selected on the radio. "Pairing" does not have to be repeated. This function may need to be activated in your Bluetooth device, however.

- Push the Home button to display the selection menu for the different operating modes.
- Turn the Tune/Select to select the operating mode Bluetooth and push the Tune/Select for confirmation.
- Switch your Bluetooth device to which you want to connect the radio on and activate the pairing mode here. The device scans for Bluetooth devices in the reception range.
- When the radio is found, your bluetooth device shows its name MA-100-XXXX (the XXXX is an identification code for your radio unit).
- Select the radio at your bluetooth device.
- Start playback on your bluetooth device.
- Playback now takes place using the radio.

Important!

In order to use the Alarm clock function, please have the radio connected with a power supply so to have the Standby mode enabled. When the radio is turned on, press and release the [] button to turn the radio into standby. Standby is disabled when the radio is using internal battery.

- Choose **Alarm** from the main menu.
- Select either Alarm 1 or Alarm 2, choose **Turn on** to activate the Alarm.
- Follow the alarm wizard instructions to set the alarm.
- The wizard will guide you through the settings below:
 - Time** - Set the time for the alarm
 - Sound** - You can choose **Wake to Tone, My Favourite** as the alarm source.
 - Repeat** - You can schedule the alarm as you desire -Everyday, Once or multiple days.
 - Alarm Volume** - Adjust the volume of the alarm as you like by rotating the **[Tune/Select]** knob
 - Alarm duration** - Set the duration of the alarm from the preset options ranging from 15 to 180 minutes. The radio will be turned to standby when the selected duration of time is due.
- After the above settings are completed, press the [] button to exit and make sure the Alarm is turned on. You will see the Alarm icon appeared on the display if it is activated.

Stopping the Alarm/Activate the Snooze function

When the alarm goes off, press the [] to stop the alarm or press the **[Tune/Select]** knob to activate the Snooze feature.

When the Snooze is activated, the alarm is muted for 9 minutes and sounds again when the time is due. You can repeat the process multiple times.

To stop the "Snooze" function, press the [].



9. Sleep Timer Setting

Set the timer to turn the radio off after the selected time elapsed in the range of 15 minutes to 180 minutes.

You will see the icon appeared on the display if the timer is set.

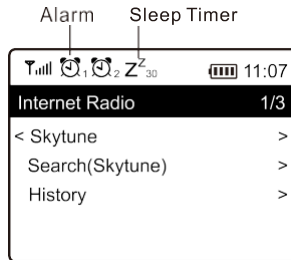

Here you will find the complete settings / options available to configure your own radio. On the Home screen, navigate to Configuration setting. Press **[Tune/Select]** and you will see a list of options available.

Network

• Network Options

Always on: The WLAN function remains switched on (faster access when switching from other modes of radio).

Auto off in 30s: The WLAN function shuts down after 30 seconds when not in use (to save energy).

• Wi-Fi Channels

Not all of the Wi-Fi channels are available in every country. There may be variation between different countries. Therefore it is necessary to choose the Wi-Fi channels to ensure the Wi-Fi performs satisfactorily.

We have already set the channels according to the requirement in different countries. Choose the country you are staying from the list to get the correct channel.

• Add / Remove AP

Add AP - It will scan out a list of access points / network around.

Add AP (WPS button) - Choose this option to connect your Wi-Fi router via WPS if the router has a WPS button.

Add AP (SmartConfig) - Choose this option to configure the Wi-Fi network with a smart phone through an app. It is available on iOS App Store and android play store. Search and install the app "EspTouch". 

Have your smart phone connected to the Wi-Fi network which the radio will be connected to.

It is recommended to place the radio within 2 meters from the router for better successful rate.

Follow the steps below:

1. On the radio, navigate to Configuration > Network > Add/Remove AP > Add AP (SmartConfig), press OK to confirm
2. Launch the App on your smart phone
3. The name of the SSID (your Wi-Fi network) will show up as follow:

10. Configuration

16:58 📶 🔋

EspTouch

SSID: KCG_NET_2G
BSSID: 6c:b0:ce:20:9b:18

Password:

Device count:

Broadcast Multicast

4. Enter the password of your network.

5. Tap "Multicast" followed by "Confirm" to complete.

17:00 📶 🔋

EspTouch

SSID: KCG_NET_2G
BSSID: 6c:b0:ce:20:9b:18

Password:

Device count:

Broadcast Multicast

The device is connected after startup
Please make sure the network is 2.4G
The device only supports 2.4G

APP-v1.3.2 / SDK-v0.3.7.0

6. The radio will start associating with the network and followed with the message "Association complete" if network is successfully connected.

Remove AP - If you have already added a router and want to remove it, choose this option.

Note - Always bring the radio within 2 meters of the Wi-Fi router for setup.

- **AP: []**

If you have added more than one routers on the radio and want to switch to another one, select this option to change.

- **Signal**

This is to show the strength of the Wi-Fi Signal of the Wi-Fi router as received by the radio. Usually signal levels lower than -70dBm is at weaker level and if it affects the reception of your radio, you may need to optimize the router location or check any problem of the router itself.

- **IP**

The IP is set Dynamic by default. Select to change Fixed IP according to your network condition.

- **DNS**

The DNS is set Dynamic by default. Select to change <Fixed> DNS according to your network condition.

Date and Time

The radio will set your local time automatically after the internet connection is completed. If you want to do manual setting, change it by the following options:

- **Time zone**

Auto-set Time Zone: This option is set by default.

Manual-set Time Zone: Choose this option if you want to set the time in another region. Choose and highlight the region/city you prefer and press OK to confirm.

Coupled with NTP (use network time) and DST (Daylight time saving) will be adjusted automatically if you choose to use network time (NTP).

- **Set Time Format**

Choose either 12-hour or 24-hour notation you prefer.

- **Set Date Format**

- **DST (Day Light Saving)**

Enable on/off

- **NTP (Use network time)**

NTP is designed to synchronize a device's clock with a time server. Your radio will synchronize the time server by default every time it powers up and connects to Internet. This ensures a very high degree of accuracy in the radio's clock. You can change to use other time server by inputting the URL address (see below NTP server). You can choose "Do not use network time" if you don't want it to.

If you choose not to use NTP for clock synchronization, highlight the NTP (Network time protocol) and press OK to make the change. You will see the Set Date & Time appeared on the menu. Select it and adjust the date and time as you desire.

- **NTP Server**

NTP is designed to synchronize a device's clock with a time server. Here it shows the server being used for the radio.

10. Configuration

Language

You can choose other languages as preferred. **[Tune/Select]** knob to the item with  and press **OK**. Scroll to highlight and press **OK** to select your language of choice. English, French, Spanish, Italian, German, Dutch, Polish, Russian and Simplified Chinese are available.

Playback Setup

This is to set the mode of playback under UPnP/DLNA compatible streaming: Repeat All, Repeat Once or Shuffle.

Resume Play Options

- **Resume once ready**

This is set by default. The radio will resume playing the last played station when it is power on the next time.

- **Stay at home**

Choose this option if you want the radio to stay on the Home screen without playing anything when it is power on the next time.

Dimmer

You can set the backlight level for the display as you prefer. There are two settings: Mode and Level

- **Mode - Normal or Power Saving**

Normal - the display will stay with the same level of brightness all the time without dim down.

Dim - the display will dim down after 20 seconds if no operation is made on the radio.

- **Level - Bright and Dim**

Bright - This is to adjust the level of brightness in Normal mode.

Dim - This is to adjust the level of brightness in Dim mode.

- **Dimmer in Standby (Standby is only enabled when power is connected)**

The display brightness in standby mode can be adjusted manually by turning the rotary knob **[Tune/Select]**. If no action taken in 20 seconds, it will stay with the dim value as set in Configuration.

EQ(Equaliser)

Various music genres can be set.

Buffer Time

Sometimes you may experience uneven playback of the internet radio. This can happen if the internet connection is slow or network congestion occurs. To help improving the situation, you can choose longer buffer time to get a few seconds of radio stream before beginning to play.

The default value is 2 seconds. You can choose 5 seconds if you prefer to have a longer buffering time.

Information

View the Network and System Information of your radio.

When you use your PC to manage the My favorite stations, you have to use the IP address and you can view this info from here. Then type in the IP address (Configuration > Information > Network information > IP) to your PC's browser input window

Software Update

There may be software release to upgrade features of the radio from time to time.

Check the update regularly to keep your radio up to date with the latest software.

Reset to Default

You can do the reset to clear all the settings and return to default settings.

** Please note all the Station presets, Settings and configuration will be erased after you have performed the Reset.

11. Remote control via PC / Smart phone - Tuning internet radio & manage favourites

Experience an easy way to control tuning internet radio channels and manage your favourite list via PC or Smart phone's web browser.

The supported browsers are Internet Explorer and Chrome. Have your radio stayed on the Internet radio mode when using this feature.

- Connect your PC or Smart phone to the same Wi-Fi network as your radio.
- Visit **www.skytune.net**
- On the home page, click "Browse/Search"



- Browse or enter the name to search the radio channel, a list of internet radio channels will be displayed.
- Click the "♥" symbol

Result for Searching 'dance'



1.fm 90's
Dance



1.fm Dance
One



101.RU - Club
Dance



101.RU -
Russian Dance



11. Remote control via PC / Smart phone - Tuning internet radio & manage favourites

- It will prompt you whether to "Add Favourite" or "Listen to Station". Enter the IP address of your radio (e.g. 192.168.1.11):

Add Favourite / Listen to Station ✕

Which operation do you want to apply to the station ?

1.fm Dance One

Add station to my radio device favourite

Listen to station on my radio device

Please enter your radio device's IP below.

192 . 168 . 1 . 11

The IP address can be located on the radio unit as follow:

* On the radio, return to the main menu. Navigate to **Configuration > Information > Network Information > IP**

- Select "Listen to Station", click "Send" and the radio unit will switch playing the channel and the "My Favourite" page will pop up on the web browser. You can then choose to add the playing station to favourite or manage your list by other edit options. Any changes will synchronize to the radio unit immediately.

11. Remote control via PC / Smart phone - Tuning internet radio & manage favourites

MY FAVOURITE

Channel Group : E00T

	Channel Name	URL								
1.	DJ AAM Radio FM	*****	Edit	Delete	Top	Up	Down	Bottom		
2.	Country Radio Switzerlar	*****	Edit	Delete	Top	Up	Down	Bottom		
3.	Bigbeat	*****	Edit	Delete	Top	Up	Down	Bottom		
4.	24Radio Switzerland	*****	Edit	Delete	Top	Up	Down	Bottom		
5.	AFN American Freedom	*****	Edit	Delete	Top	Up	Down	Bottom		
6.	Energy Berlin	http://energyradio.de/bremen	Edit	Delete	Top	Up	Down	Bottom		
7.	MP3 Pro	http://www.katrafm.com/katrafm_mp3pro.m3	Edit	Delete	Top	Up	Down	Bottom		
8.	2	http://www.ultranet.biz/vegasandanski.m3u	Edit	Delete	Top	Up	Down	Bottom		
9.	stream 2	http://lindowsradio.com:8600/listen.pls	Edit	Delete	Top	Up	Down	Bottom		
10.	aac 128	http://eastlondonradio.com:8100/bighigh.aac	Edit	Delete	Top	Up	Down	Bottom		
11.	Seoul Shoutcast	http://yp.shoutcast.com/sbin/tunein-station.	Edit	Delete	Top	Up	Down	Bottom		

Add Channel

Channel Name	URL	Submit	Reset
<input type="text"/>	<input type="text"/>		



You can also add the radio channel if you know the published audio stream URL with the streaming format as follow:

1. Audio formats: MP3, AAC, AAC+
2. Stream formats: Shoutcast, Icecast (HTTP, HTTPS) and HLS
3. Playlist formats: PLS, M3U
4. Sampling frequency: 44.1 KHz and 48 KHz

12. Trouble Shooting

Problem	Cause	Solutions
Cannot connect to Wi-Fi network	Network down	<ul style="list-style-type: none"> • Confirm that a Wi-Fi or Ethernet Wired connected PC can access the internet (i.e. can browse the web) using the same network. • Check that a DHCP server is available, or that you have configured a static IP address on the radio. • Check that you firewall is not blocking any outgoing ports. As a minimum the radio needs access to UDP and TCP ports 80,443 and 8008, DNS port 53.
	Router restricts access to listed MAC addresses	Obtain the MAC address from Configuration > Information > Network > Wi-Fi MAC and add to the allowed equipment list on your access point. Note: The radio has separate MAC addresses for wired and wireless networks.
	Insufficient Wi-Fi signal strength	<ul style="list-style-type: none"> • Check distance to router; see if a computer can connect to the network in this location • Optimize the distance of the router's location
	Unknown encryption method	Change encryption method on router. The radio supports WEP, WPA, WPA2
	Firewall preventing access	Disable the fire wall to see if radio can connect to the network. Windows Media Player: varies — non-Microsoft firewalls may require configuration for UPnP.

12. Trouble Shooting

Problem	Cause	Solutions
<p>If your radio can connect to the network successfully, but is unable to play particular stations</p>		<ul style="list-style-type: none"> • The station is not broadcasting at this time of the day (remember it may be located in a different time zone). • The station has too many people trying to attach to the radio station server and the server capacity is not large enough. • The station has reached the maximum allowed number of simultaneous listeners. • The link on the radio is out of date. The update of the link is done regularly. To get the updated list of stations, please access from Internet radio > Skytune. In case a particular stream is still not working, please contact us or report the case to Skytune.
<p>No sound</p>		<ul style="list-style-type: none"> • Please check if the playback is stopped. Press the Tune/Select knob to resume playback. • Adjust the volume • Check if other radio stations have the same problem or just happened on a particular station. <p>If external speaker is connected to the line-out jack:</p> <ul style="list-style-type: none"> • Adjust the volume level of the external powered speaker. • Please check if the power of the external powered speaker is switched on.
<p>Radio got freeze or no response</p>		<p>Carry out a reset as follow: On the radio unit, press the  and  buttons together until the radio is off (screen is blank), then release both buttons.</p>

1. If the Internet Radio keeps re-buffering radio station:

The Internet Radio is streaming the data from the radio station via your broadband connection, if there is a high error rate on your broadband connection, or the connection is intermittent, then it will cause the Internet Radio to pause until the connection is re-established and it has received enough data to start playing again. If your Internet Radio keeps stopping, please check the DSL modem to ensure that the Broadband line is not suffering a high error rate or disconnections. If you are experiencing these problems, you will need to contact your broadband supplier.

2. What is Buffering?

When playing a stream, the Internet Radio/Media player, downloads a small amount of the stream before it starts playing. This is used to fill in any gaps in the stream that may occur if the internet or the wireless network is busy.

The Internet Radio streams music data from the PC while you are listening. If a stream gets blocked or experiences Internet congestion while transferring it may stop/interfere with the quality of play. If this happens, check your internet connection speed- it must be faster than the speed of the streams.

3. My radio is working but some stations cannot be played.

The problem may be due to one or more of the followings:

- a. The radio station is no longer broadcasting.
- b. The radio station has reached the maximum allowed number of simultaneous listeners.
- c. The radio station has changed the stream arrangement and the link is no longer valid.
- d. The radio station is not broadcasting at the time of the day (not all stations are broadcasting 24 hours throughout the day).
- e. The Internet connection between your radio and the radio station server is too slow or unstable to support the data rate of the broadcast.

Technical Specification

Model	IR-135
Power input	5V \pm 1A
Power voltage	100-240V~50/60Hz
Wireless Network	IEEE802.11b/g/n
Wireless network frequency	2412 - 2484 MHZ
Wireless transmission power	Typical transmission power 14 dBm (72.2 Mbps); 20 dBm (11b mode)
Security Protocol	WEP/WPA/WPA2
Bluetooth version	V4.2 BR/EDR compliant
Bluetooth frequency	2.4 GHz
Bluetooth range	10 meters (line of sight)
Built-in Lithium-ion battery	3.7V, 2000 mAh
Audio output	Stereo earphone jack 3.5 mm Stereo line out
Unit Dimension	180 x 110 x 105 mm (L x D x H)

Remark: Specification may vary without notice

- * Internet Radio
- * USB cable
- * User manual

WEEE and Recycling



The European laws do not allow any more the disposal of old or defective electric or electronic devices with the household waste. Return your product to a municipal collection point for recycling to dispose of it. This system is financed by the industry and ensures environmentally responsible disposal and the recycling of valuable raw materials.