



Original manual

SEL-80140



facebook.com/denver.eu

Before operating this vehicle, read all the instructions for safe assembly and operations. User's manual can guide you through the functions and usage of Electric scooter. Before using this Electric scooter, familiarize yourself with how to operate, so that you can keep the Electric scooter in the best condition possible.

This appliance can be used by children aged from 14 years and above and persons with reduced physical, sensory or mental capabilities or lack of experience and knowledge if they have been given supervision or instruction concerning use of the appliance in a safe way and understand the hazards involved.

Children shall not play with the appliance.

Cleaning and user maintenance shall not be made by children without supervision.

The appliance is only to be used with the power supply unit provided with the appliance.

This appliance contains batteries that are not replaceable.

Version 1.0

Table of Contents

1	Product and Accessories	3
2	Unfolding and folding the scooter	4
3	Handle bar assembly	5
4	Charging the scooter	7
5	Intended Use	8
6	Safety Instruction	8
7	Maintenance	9
8	Operational control	11
9	Electric scooter riding	12
10	List of parameters	14
11	Electric scooter safe parking	15
12	Safe transportation	15
13	Warnings	15

1 Product and Accessories

Important!

This electric scooter must be charged and stored in a safe way.

For safety reason and protect battery life, never charge the electric scooter in temperatures below 5 °C or above 45 °C. Equally, always disconnect the electric scooter with the power cable once fully charged. Always use the supplied power adapter to charge the electric scooter.

Make sure that all screws are properly tightened to avoid unsafe situations.

WARNING

- Please make sure to check that the steering system is correctly adjusted and that all connection components are firmly secured and not broken before riding, refer to handlebar assembly and safety instruction.
- Please read operation guide and warnings of correct techniques for use and braking
- Always wear shoes.
- When self-locking nuts and other self- locking fixings may lose their effectiveness.
- All parts and materials of electric scooter cannot be changed, modifications are not allowed.

1. Product and Accessories



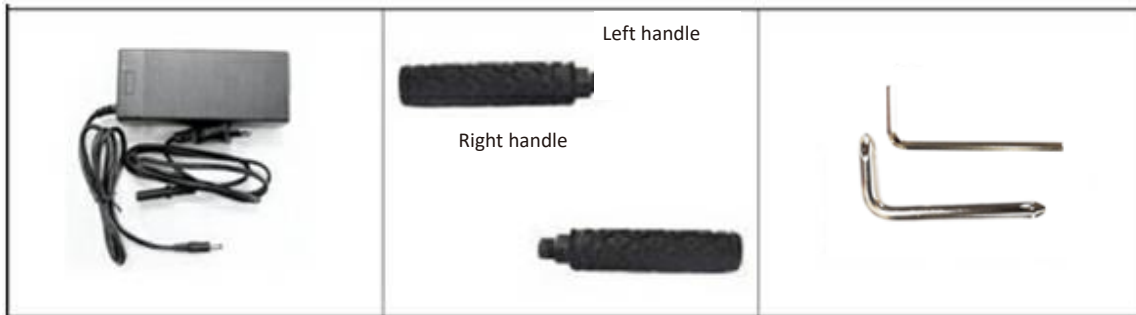

2 Unfolding and folding the scooter

Unfold the Electric scooter

- 1) Stand the Electric scooter on its wheels, and press the unlock clasp.
- 2) Pull up the handle in a gentle way.
- 3) The Electric scooter is unfolded as soon as you hear the rod click into place.



Fold the Electric scooter

- 1) Hold the clasp and pull it outward.
- 2) Press the front tube of Electric scooter downward (Attention: the limit position must be put right.)
- 3) The rod clicks audibly into place.



4) Dual action safety knob

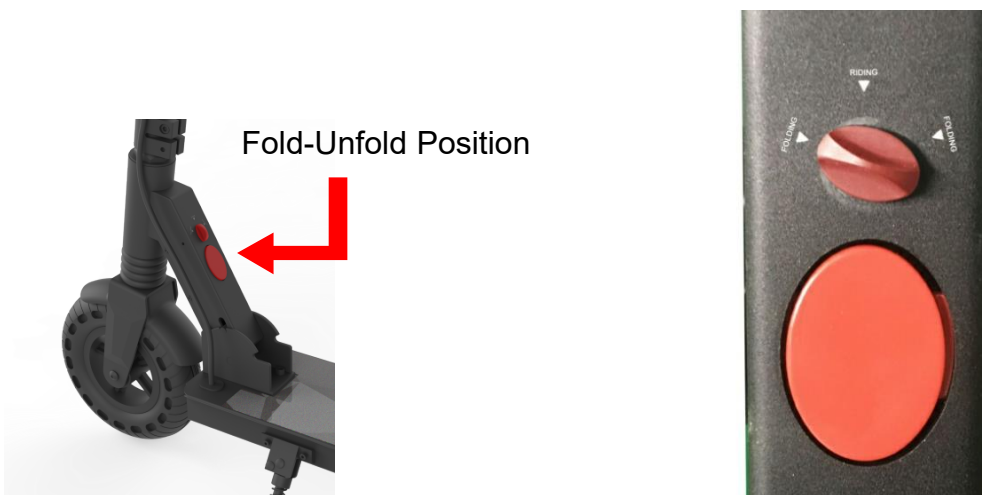



Press the red button to fold or unfold the Electric scooter.

Rotate the safety knob to the “FOLDING” position on the left or right, then press the red button to fold your Electric scooter. Rotate the safety knob to the “RIDING” position, you can start your driving.

⚠ WARNING

The knob must be set to the “RIDING” position when riding for safety issue to prevent unintended folding the Electric scooter.

3 Handle bar assembly

- 1) Parts inside the packaging: two handlebars
- 2) Change display angle: Loosen the screw  on the handle bar, and rotate the axle  to make the handlebar meter screen upwards while the  and display screen turn inwards in a horizontal level. Remember to tighten screws again.
- 3) Before operating the electric scooter, turn the handlebar grips, and carefully check all the

components to make sure that the steering is correctly installed as described above, and that all connecting parts are secure and fully functional.



Figure 1

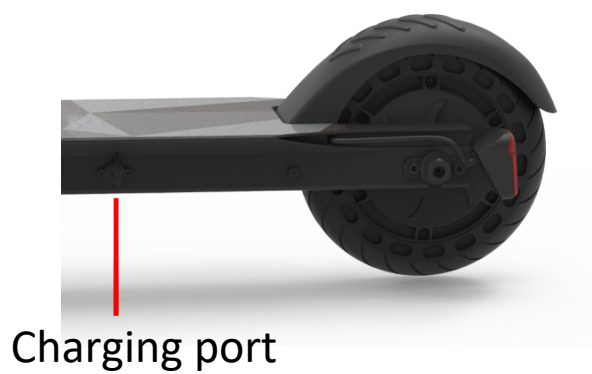

Figure 2

4 Charging the scooter



Connect the supplied power adapter to the charging port of the electric scooter.



5 Intended Use

The Electric scooter is neither a means of transport nor sports equipment, but a device for personal entertainment. The Electric scooter for domestic use only and only by a person aged at least 14 with a maximum weight of 100 kg. The other parameters for the permissible operation of the Electric scooter are defined in the section (“10. List of parameters”) . Importantly, the Electric scooter may only be operated in good visibility conditions and only if the physical conditions for stability on the Electric scooter are met (for example, not on one leg/not under the influence of drugs or alcohol). When operating the electric scooter, the operator must wear personal protective equipment specified in the section (“13. Warnings” > 13.2 Preparation”).

6 Safety Instruction

We recommend always wearing helmet and protective gear like elbow, knee and wrist protectors to ensure your personal safety.



Also make sure you have read the user manual carefully, to ensure you know how to ride it in a safe and fun way.

The Electric scooter is for domestic use only.

It is your responsibility to be aware of and comply with all regulations. If there are no regulations for this Electric scooter in your country, please take care of your own safety and the safety of others.

Also pay attention to other people. Always ride safely and only at a speed that allows you to brake safely at any time. A common thing for such products is that there is a risk that you may fall off the product and injure yourself. Always ride as safely as possible.

If lending the electric scooter to friends and family, please make sure they use proper protective gear and know how to ride it.

Before riding the electric scooter, please check that all parts are working as supposed to. If any loose parts, abnormal noise, reduced battery life etc. are detected, please contact your retailer for product service and warranty. Do not repair the electric scooter yourself.

Inspect the rear tire, rear brake, and brake pad according to Section 7 of the maintenance specification in this operating instructions. The electric scooter may become unstable if the rear brake is deformed or loose. This is because the distance between the brake pad and the rear wheel becomes too small, possibly leading to a blocked rear wheel.

Avoid applying too much force or stepping on the rear fender permanently. This may cause the fender to

loosen or damage the spring holding the fender.

As a result, the brake pad constantly touches the wheel and the motor temperature increases due to the additional resistance. The rear tire can also get loose if the brake is in constant braking position.

Avoid constant braking. As a result, the tires will not only wear off, but also become hot. This will soften the rubber and it will no longer have the same grip on the road as usual. Do not touch the tire after braking.

If you hear unusual noises or notice friction when switching on the electric scooter, a bearing may be damaged. A worn bearing may even be indicated by strong vibration of the handlebar. In this case, please contact your retailer since the bearing needs to be replaced and/or the handlebar checked and adjusted.

Ride the electric scooter only on a dry surface since otherwise the riding safety and braking performance may be impaired and the motor or bearings may be damaged.

Please do not ride up or down long and steep slopes.

Stop riding when you receive the "Low Battery Warning". The electric scooter then moves only slowly and does not have the same traction as normal and the electric brake does not work. In this case, please use the rear brake to stop the electric scooter. Get off the Electric scooter as soon as the speed allows to do that safely.

Do not use the electric brake and the throttle at the same time.

A normally working Electric scooter operates safely and quietly. If you hear noises or notice bumpy operation, please check wheels, bearings, and brakes. Contact your customer service for repair and maintenance, if necessary.

7 Maintenance

To ensure you get the best possible performance and experience from your electric scooter, it is important to do regular maintenance for important parts of the product.

- Battery maintenance
- Bearings, Screws, Brakes and Wheels
- Storage and Cleaning

Your electric scooter will require some maintenance so please read and familiarize yourself with this guide.

● Battery maintenance

All batteries have a life cycle, and performance will decrease over time, however here are some advice to maximize the life span of the battery.

Make sure that the battery is charged at regular intervals, even if you do not use the electric scooter for a long time. This is to prevent damage to the battery, caused by low voltage over an extended period.

Avoid draining the battery completely. It is best to charge while there is still power on it. This will extend battery life. If the battery is constantly depleted, it will damage the battery (damaged battery caused by wrong handling are not covered by the warranty).

If riding the electric scooter in cold or very hot areas, the battery time can be lower than when riding in

temperatures from 15-25° Celsius. This is not a failure on the batteries, but normal behavior.

Please notice: Even a fully charged battery will run out of power if the electric scooter is not used for a period. Expect a fully charged battery to keep power between 90 and 120 days in off mode, before it is fully discharged. If only partially charged, this period is lower.

Please make sure the battery does not get above 50° Celsius, or below minus 10° Celsius for a longer period. (e.g. don't leave the electric scooter in a hot car in summer, do not put battery into fire etc.) Low temperature (e.g. subzero temperature) can damage the battery cells.

Keep the Electric scooter away from open flame or other sources of heat to prevent the battery from getting too hot. Also make sure not to leave the electric scooter at freezing temperatures. Both heat and excessive cold can cause the battery to discharge.

Only use original charger or an official replacement, as different batteries may require specific charger, and if using other chargers, this could cause damage to the product.

Do not overcharge and discharge the battery.

Please make sure to charge the battery before it is completely out of power, to avoid damaging the battery cells. (damaged battery caused by wrong handling are not covered by the warranty)

It is forbidden to disassemble battery package. This is only to be handled by official service repair centers and professionals.

● Bearings, Screws, brakes and Wheels

Your electric scooter is made up of moving parts, which in time, will be susceptible to wear and tear.

Bearings and screws:

The electric scooter has sealed and dustproof bearings so that no lubrication is required. Check the bearings for wear at regular intervals to avoid unsafe riding. Do not jump on and off and do not apply excessive force otherwise to avoid damage to the bearings. This is not a sports electric scooter.

Make sure that all screws are properly tightened to avoid unsafe situations.

Please check the screws regularly and tighten if they seem loose.

Brakes:

Check the brake for wear at regular intervals to avoid unsafe riding. Do not apply excessive force to avoid damage to the brake.

Wheels:

Check the wheels for wear at regular intervals to avoid unsafe riding.

Electric scooters come with different wheels but can in general be separated into tires with inflatable inner tubes and solid wheels.

For inflatable tires, please make sure to keep the right pressure, as hard tires will last longer.

If the wheel seems wobbly even after screws are tightened, the bearings might be worn down and need replacement



- Please make sure to check that the steering system is correctly adjusted and that all connection

components are firmly secured and not broken before riding, refer to handle assembly and safety instruction.

- Please read operation guide and warnings of correct techniques for use and braking
- Always wear shoes.
- We highly recommend to always wear helmet/pads for your own protection.
- Self-locking nuts and other self- locking fixings may lose their effectiveness.
- All parts and materials of electric scooter cannot be changed, modifications of the scooter are not allowed. If done, then warranty is void.

● Storage and cleaning

If your Electric scooter gets dirty, please clean it with a damp cloth only, you may not use pressured water - gun or running water, as this could damage vital parts. It is also possible to use a little toothpaste if the dirt is stuck. Remember to clean with damp cloth after this.

Please make sure to keep the electric scooter turned off while cleaning it, and make sure to cover the charging input to avoid problems with the electronics.

Make sure to dry the scooter with a towel, should it become wet.

Please notice: Do not use alcohol, gas, kerosene or other corrosive and volatile chemical solvents. This can damage both the appearance and the internal structure of the electric scooter.



Please store your Electric scooter in a dry and cool environment when not in use. Avoid leaving it outdoors, as it is not made for storing in wet areas. Nor is it good to expose to high temperatures caused by direct sun for a long time.

8 Operational control

For better operation, please read the instructions carefully.



8.1 Button

There are three buttons in the display,  Power button,  Speed up button and  Speed down button.

8.2 Control and display

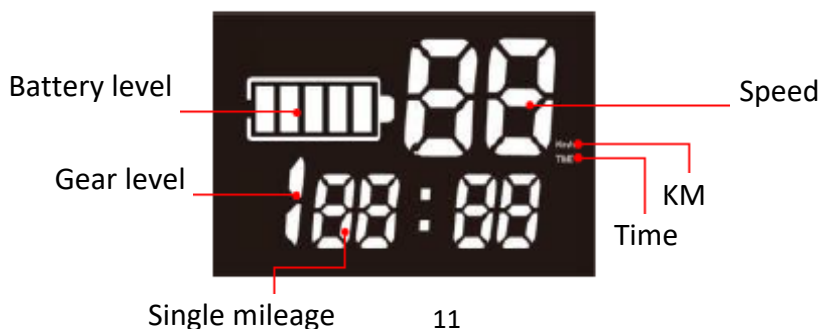

Power On: Long press the power button until the display lights up.

Power Off: Long press the power button until the display goes out and the system is off.

1. Battery power display: it shows the current remaining battery capacity.
2. Power off automatically: After the display is idle for more than 5 minutes, the Electric scooter automatically turns off.

Change display information: When the Electric scooter is on, short press the power button , change the showing data on the display, TIME, ODO, DIS and other characters respectively. When it is showing time, it indicates the running time after switching on. The time will be cleared after switching off. When it is showing DIS, it indicates the driving distance after switching on, and it will be cleared after power off. When it is showing ODO, it indicates the total mileage, which will be retained unless it is manually cleared.

Change the gear: Short press ▲ or ▼ button to change the gear level (Gear 3 is fast speed, Gear 2 is medium speed, and Gear 1 is slow speed).

Acceleration: Gently press the accelerator button to speed up (The depth of the press is related to the gear level you have set).

Deceleration: Gently press the deceleration dial to slow down. The deeper the press, the greater the deceleration (the deceleration is relevant to the formation of the press, and pushing too hard can not increase the braking force and may cause damage to the brake dial).

Clear total mileage: Press ▲ and ▼ buttons at the same time, then press the power button  to switch on the Electric scooter, and the total mileage will be cleared.

Important: Press ▲ and ▼ buttons at the same time, then press the power button  and select P3 mode, when parameter value is 0, it will start with zero. When parameter value is 1, it will start with non-zero.

(Zero start: When starting, the Electric scooter in a stationary case, press the accelerator to start driving.)

(Non-zero start: When starting, the Electric scooter is static, press the accelerator and the Electric scooter does not work, push the Electric scooter manually to start driving, the Electric scooter works. factory default is non-zero start.)

You have to manually move the Electric scooter with your foot before the accelerator button works.

9 Electric scooter riding



1. Press ▲ and ▼ buttons to adjust speed level.
2. Press the accelerator button to accelerate, so you can drive.
3. Press the brake button to brake.
4. When you press the accelerator and electric brake button at the same time, the Electric scooter will automatically brake
5. For safety, the rear wheel brake system must be used when driving at high speed.

9.1 Front and Back LED Light

This Electric scooter is equipped with the front and back LED lamps. The front lamp lights white and the back lamp lights red.

1. Walking mode: 6KM/H, when 1 mode, the front and back light will be flashed.
2. 2/3 mode: when 2/3 mode and when brake, front and back light will be on, and can not flash. User can also press the “▲” key by 5S to turn on/off the light.



10 List of parameters

Parameter		Range
Size	Folding size(mm)	980*152*370
	Unfolded Size(mm)	1080*425*980
Quality	Max Vehicle Payload(kg)	100
	Weight (kg)	12
Ride Condition	Age(Year)	14+
Electric scooter	Max. speed (horizontal riding) (km/h)	20
	Distance up to (km)	12
	Terrain	Level and dry surface
Battery Type: Li-ion battery	Nominal voltage (V)	36
	Input voltage (V)	42
	Battery capacity (mAH)	4000
Motor	Motor Power (W)	300
	Emission sound pressure level (DB)	Emissions < 70 db (A).
Power adapter	Rated input voltage (V)	100-240
	Rated output voltage (v)	42
	Rated current (A)	2
	Charging Time(h)	3

Electric scooter

Model: SEL-80140

Input: 100V-240V~, 50/60Hz, 2.5A(Max)

Output: 42V  2A  

Max Speed: 20km/h

Weight: 12 kg

Year Of manufacture: 2022

Max Vehicle Payload: 100kg

Battery: 36V/4Ah

Power Consumption: ≤ 300W

Always charge the electric scooter with the supplied power adapter: XHK-800B-4220

DENVER A/S

Omega 5A Soefte DK-8382 Hinnerup

Denmark

www.denver.eu

11 Electric scooter safe parking

Once you have stopped the Electric scooter, get off it and press the side stand down with your right foot to support the Electric scooter. The side stand is located on the left-hand side of the Electric scooter below the foot board.

Before you ride again, push the side stand back up so that it is parallel to the foot board.

12 Safe transportation

Pack the Electric scooter flat, don't drop the Electric scooter during the transportation, don't put the Electric scooter near fire or explosive materials.

13 Warnings

13.1 Risks of riding



First, learn safe riding before you ride the Electric scooter fast.

- Failure to observe, loss of control, falls, and violations of the rules can cause injuries.
- Speed and range depend on the rider's weight, terrain, temperature, and riding style.
- Wear a helmet and protective clothing when riding the Electric scooter.
- Read the operating instructions carefully before riding the Electric scooter.
- For use only in a dry environment.
- The Electric scooter may not be used on public roads.
- Make sure that this product complies with local regulations.
- For domestic use only

13.2 Preparation

- First, charge the battery completely.
- Wear a helmet, knee and elbow pads, as well as earmuffs/earplugs.
- Do not wear loose clothing or open laces that can get caught in the Electric scooter wheels.

13.3 Weight restriction

Reason for the weight restriction:

- Ensuring the rider's safety;
- Avoiding damage due to overload.

Maximum Vehicle Payload: 100kg.

 **WARNING**

Do not try to make a turn too fast.

 **WARNING**

Lithium battery inside.

 **WARNING**

If the Electric scooter switches off, the system will block the vehicle automatically.

It can be released again by pressing On/Off.

- Use the device only at temperatures between -10 °C and +45 °C.

13.4 Range per charge

The range depends on several factors:

- Topography: On level paths you have a greater range than on uneven ground.
- Weight: The range depends on the rider's weight.
- Temperature: Extreme temperatures reduce the range.
- Maintenance: If the Electric scooter is charged properly and the battery is kept in good condition, the range will be extended.
- Speed and riding style: The range is greater at constant speed than at frequent stops and starts, acceleration and braking.

13.5 Safe riding

This chapter focuses on safety, experience, and warnings. Before operating the vehicle, please read all installation and operating instructions carefully.

 **WARNING**

Familiarize yourself with the vehicle before you use it so that you can keep the Electric scooter in sound condition.

- Observe all safety instructions when riding the Electric scooter.
- The Electric scooter is designed only for personal entertainment. Avoid operating it on public roads/in road traffic.
- Children, elderly people, and pregnant women are not allowed to ride the vehicle.
- People with limited sense of balance are not allowed to ride the Electric scooter.
- Avoid riding the Electric scooter under the influence of alcohol or other substances.
- Do not carry any objects while riding.
- Make sure you have a clear vision in front of you to ride the Electric scooter safely.

-
- While riding, your feet must always be on the foot board.
 - The Electric scooter can accommodate only one person.
 - Do not start or stop abruptly.
 - Avoid riding on steep slopes.
 - Stop riding the Electric scooter if you hit a solid object (such as a wall or other structure) with it.
 - Do not ride in dimly lit or dark places.
 - Ride the Electric scooter at your own risk, we assume no liability for accidents or damage.
 - Ride at a safe speed that allows you to stop at any time.
 - Keep the Electric scooter at a sufficient distance from other people and avoid collisions.
 - Steer through balance shifting, fast movement can result in falls.
 - Do not ride in rain or under other wet conditions. Ride only in dry weather.
 - Avoid riding over obstacles, if possible, and avoid snow, ice, and slippery surfaces.
 - Avoid riding over textiles, small branches, and stones, if possible.
 - Avoid riding in narrow places or in places with obstacles, if possible.
 - Jumping on and off the Electric scooter will cause damage that is not covered by the warranty. There is a risk of injury. Injuries and damage due to "trick riding" are not covered by the warranty.
 - **Stand on the pedal with one foot, push the other foot back on the ground and start sliding. The motor can only start after the vehicle speed reaches 3km/h.**

13.6 Charging

- Make sure that the Electric scooter, charger, and DC power input of the device are always dry.
- Note: To charge this Electric scooter, use SOLELY the supplied XHK-800B-4220 charger with the following output: 42 V -2 A.
- Using a different charger may cause damage to the device and other potential risks.
- Use the mains adapter to plug the DC input of the device into a conventional socket.
- There will be no light on the charger before charging, when connected to e-scooter the adapter will light red, and charging has started.
- The red indicator lights up when properly charged; if this is not the case, please check the connections.

- Now you can stop the charging cycle. Overcharge shortens the battery life.
- The charging process takes up to 3 hours. Do not charge the battery for more than 3 hours. After 3 hours, disconnect the charger from the device and the power supply. Overcharge reduces the battery service life.
- The product must not be charged over extended periods.
- Always keep an eye on the device throughout the charging cycle.

-
- Charge the device only at temperatures between 0 °C and +45 °C.
 - When charging at lower or higher temperatures, there is a risk that the battery performance will be reduced. Therefore, there is a potential risk of injuries and material damage.
 - Store and charge the device in an open, dry area away from combustible materials.
 - Do not charge the device in direct sunlight or in the vicinity of open flames.
 - Do not charge the device immediately after use. Allow the device to cool down for an hour before charging it.
 - If the device is left to other people, it must be charged partially (20 - 50%), not fully.
 - Do not remove the device from its package to fully charge it and then put it back in the package.
 - The device is generally partially charged as shipped from the factory. Keep the device partially charged until it is used.
 - Allow the Electric scooter to cool down for at least 1 hour before it can be put in the package.
 - Do not leave the device exposed to sunlight in a car.

CAUTION

The Electric scooter must not be used during the charging cycle!

- The LED indicator on the battery charger lights red during the charging process.
- The LED indicator on the charger will light green when the charging process is complete.
- After charging, disconnect the charger from the mains and the Electric scooter.

CAUTION

Connect the DC cable supplied with the Electric scooter only to the DC input!

- Do not insert foreign objects into the DC input.

CAUTION

- Do not remove the protective cap from the DC input!
- Remove the cap only when charging the Electric scooter!
- After charging, disconnect the DC plug and close the DC input again with the cap!

⚠ WARNING

Make sure that neither water nor other liquids penetrate into the inner components of the Electric scooter; otherwise, the electronics/batteries of the device could be permanently damaged. There is a risk of injury.

CAUTION

- Do not open the electric scooter casing, otherwise the warranty is invalidated.

⚠ WARNING

- Make sure to wear helmet and protective clothing before using the Electric scooter.
- Make sure to read manual carefully before using the Electric scooter.
- The Electric scooter is not intended for use on public roads nor in traffic

-
- The Electric scooter must only be used on dry and level ground
 - For domestic use only
 - The Electric scooter may not be used by anyone under age of 14 years

IMPORTANT! Read carefully and keep for future reference.

Any load attached to the handlebar will affect the stability of the vehicle.

Accessories and any additional items which are not approved by the manufacturer shall not be used.

WARNING ! As with any mechanical component, a vehicle is subject to high stresses and wear. The various materials and components may react differently to wear or fatigue. If the expected service life for a component has been exceeded, it may break suddenly, therefore risking causing injuries to the user. Cracks, scratches and discoloration in the areas subject to high stresses indicate that the component has exceeded its service life and should be replaced.

Traffic in the city has many obstacles to cross such as curbs or steps. It is recommended to avoid obstacle jumps. It is important to anticipate and adapt your trajectory and speed to those of a pedestrian before crossing these obstacles. It is also recommended to get out of the vehicle when these obstacles become dangerous due to their shape, height or slippage.

WARNING Keep plastic covering away from children to avoid suffocation.

Take the time to learn the basics of the practice to avoid any serious accident that can take place in the first months;

Get closer to your seller so he can refer you to an appropriate training organization.

- In any case, anticipate your trajectory and your speed while respecting the code of the road, the code of the sidewalk and the most vulnerable.
- Notify your presence when approaching a pedestrian or cyclist when you are not seen or heard.
- Cross the protected passages while walking.
- In all cases, take care of yourself and others.
- Do not divert the use of the vehicle.
- This vehicle is not intended for acrobatic use.
- Caution, the brake may become hot in use. Do not touch the brake disc after use.
- Eliminate any sharp edges caused by use.

Power-off the vehicle during charging.

Self-tightening nuts as well as the other self-tightening fastenings may lose their efficiency and that they may need to be retightened;

According to French traffic rules, reflective clothing and helmet is strongly required during cycling.

Please notice - All products are subject to change without any notice. We take reservations for errors and omissions in the manual.

ALL RIGHTS RESERVED, COPYRIGHT DENVER A/S



Electric and electronic equipment and included batteries contains materials, components and substances that can be hazardous to your health and the environment, if the waste material (discarded electric and electronic equipment and batteries) is not handled correctly.

Electric and electronic equipment and batteries is marked with the crossed out trash can symbol, seen below. This symbol signifies that electric and electronic equipment and batteries should not be disposed of with other household waste, but should be disposed of separately.

As the end user it is important that you submit your used batteries to the appropriate and designated facility. In this manner you make sure that the batteries are recycled in accordance with legislature and will not harm the environment.

All cities have established collection points, where electric and electronic equipment and batteries can either be submitted free of charge at recycling stations and other collection sites, or be collected from the households. Additional information is available at the technical department of your city.

DENVER A/S

Omega 5A, Soeften

DK-8382 Hinnerup Denmark

facebook.com/denver.eu

Regarding Battery charging SEL-80140

Important – Please read!

Dear customer. We hope you get a lot of joy out of your new Electric scooter.

The battery built in the Electric scooter is not fully charged from production line and when left unused the battery can slowly discharge by itself.

This can lead to slow charge if the battery is fully discharged, but this is done to avoid damage to the battery.

If you experience that you cannot turn on your E-scooter, and it doesn't seem to charge (the charger lights up green instantly), then please do the following.

1. Leave the charger in for 6-7 hours. This will make sure the battery will be fully charged again (it can take 3-4 hours before it starts normal charging).
2. If this does not solve your problem, please ride the Electric scooter manually without turning it on. Use your legs to give speed, for around 100 m, and then connect the charger. The engine in the front wheel will this way help to activate the charging function and it will charge normally. (fully charge takes 3 hours if using this way)

Please enter: www.denver.eu to obtain the electronic version of the manual.

WARNINGS

Please read the manual completely and the instructions below before using the product.

Product names: SEL-80140

Product type: Electric scooter

Year of manufacturing: 2022



- Note: ONLY use the supplied charger labelled XHK-800B-4220 with the following output voltage to charge this Electric scooter: 42V – 2A.
- Using another charger may damage the product or create other potential risks.
- Never charge the product without supervision.
- The charging period of the product should not exceed four hours. Stop charging after four hours.
- The product should only be charged in temperatures between 0°C and 45°C.
- If charging at lower or higher temperatures, there is a risk that the performance of the battery will be reduced and a potential risk of damage to the product and personal injury.
- The product should only be used in temperatures between -10°C and +45°C.
- If used at lower or higher temperatures, there is a risk that the performance of the battery will be reduced and a potential risk of damage to the product and personal injury
- Store the product at temperatures between 0°C and 35°C. (optimum storage temperature is 25°C)
- Charge and store the product in an open, dry area and away from flammable materials (i.e. materials that may burst into flames).
- Do not charge in sunlight or near open fire.
- Do not charge the product immediately after use. Let the product cool down for one hour before charging.
- If the product is left with other persons for example during a holiday period, it should be partially charged (20-50% charged). Not fully charged.
- When shipped from the factory, the product has often been partially charged. Keep the product in a partially charged state, until it is going to be used.

DENVER A/S

Omega 5A, Soften, 8382 Hinnerup, Denmark

www.denver.eu



EC Declaration of Conformity (Machinery Directive)

The undersigned

Company Name: DENVER A/S
Address: Omega 5A, Soeften, DK-8382 Hinnerup, Denmark

certify that the design and manufacturing of this product

Product Brand Name: DENVER
Product Model No.: SEL-80140
Product type: Electric scooter

conforms to the following directives:

Machinery directive 2006/42/EC
MD Standards: Annex I of 2006/42/EC, EN ISO 12100:2010,
EN 60335-1:2012+A11:2014+A13:2017+A1:2019+A14:2019+A2:2019, EN 17128:2020.

and therefore complies with the essential requirements of the Machine Directive.

MD 2006/42/EC,
LVD 2014/35/EU
EMC 2014/30/EU, EN 61000-6-1:2007, EN 61000-6-3:2007+A1:2011.
Restriction of the use of certain hazardous substances (RoHS) : 2011/65/EU and amending directive (EU)2015/863

Name and address of the person authorized to sign the declaration and collect the technical documentation

Serial no.: 15583-01/22/00001 to 15583-01/22/01000
Full Name: Torben Balmer
Position: CEO
Company: DENVER A/S
Address: Omega 5A, Soeften, DK-8382 Hinnerup, Denmark
Date: 17 Feb, 2022

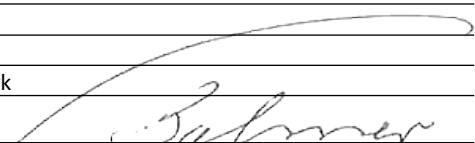

DENVER A/S | Omega 5A | 8382 Hinnerup | Denmark
Phone: +45 86 22 61 00 | E-Mail: contact@denver.eu | Web: www.denver.eu
VAT.NO: DK18831678