

DENVER[®]

User Manual

ENGLISH



Model: LDS-4371

To obtain the best performance and safety, please read this manual carefully.
Please keep this manual for future reference.

CONTENTS

SAFETY INSTRUCTIONS	2
EXTERNAL SCHEMATIC AND INSTALLATION	3
Antenna/Cable Connection	4
REMOTE CONTROLLER	5
SOURCE	6
BASIC OPERATION	6
Initial Setup	6
HOME Menu	11
Setting	11
Picture	14
Sound.....	16
Programme	17
Lock	26
PVR Option (DTV Mode)	28
Network	30
Other Information	32
Using the Features	33
MULTIMEDIA OPERATION	35
Movies	35
Music	35
Photos	35

SAFETY INSTRUCTIONS

IMPORTANT SAFETY INSTRUCTIONS - PLEASE READ CAREFULLY BEFORE USE.

The following safety instructions are located on the back of the TV.



DANGER OF ELECTRIC SHOCK! NEVER REMOVE THE SCREWS OF THE COVER. NO USER-SERVICEABLE PARTS IN THE DEVICE. REPAIR ONLY BY QUALIFIED SERVICE PERSONNEL.



The exclamation mark in the equilateral triangle indicates important operating and maintenance instructions



The flash in the equilateral triangle indicates high voltage in the device, which can lead to electric shock

Please follow the instructions below:

- ❖ Do not use this TV near water.
- ❖ Only clean the device with a damp cloth.
- ❖ Do not block any ventilation openings.
- ❖ Set up the television in accordance with the supplied quick guide and these operating instructions.
- ❖ Lay the power cable so that it cannot be stepped on or pinched. Pay special attention to the plug and the point at which the cable is led out of the television.
- ❖ Do not let the power cord hang over the edge of the table.
- ❖ Disconnect the TV from the mains if there is a thunderstorm or if it is not used for a long period



WARNING! EXPOSE THE TELEVISION TO AVOID FIRE OR ELECTRIC SHOCK OR RAIN OR MOISTURE. THE TELEVISION SHOULD NEVER BE EXPOSED TO SPLASH / DRIP WATER AND NO OBJECTS FILLED WITH LIQUID ON THE TELEVISION

NOTE: Open flames (such as candles) should never be placed on the TV
Smells from the TV

New TVs can cause unusual smells when they are switched on for the first time. Due to the manufacturing process of the components, the television and other electronic products may have parts that produce odors when they are first turned on and warmed up. The smell usually disappears after a few days of use and does not return. This is normal and occurs with many electronic devices. Ensure that there is sufficient ventilation in and around the device so that the smell can disappear.

EXTERNAL SCHEMATIC AND INSTALLATION

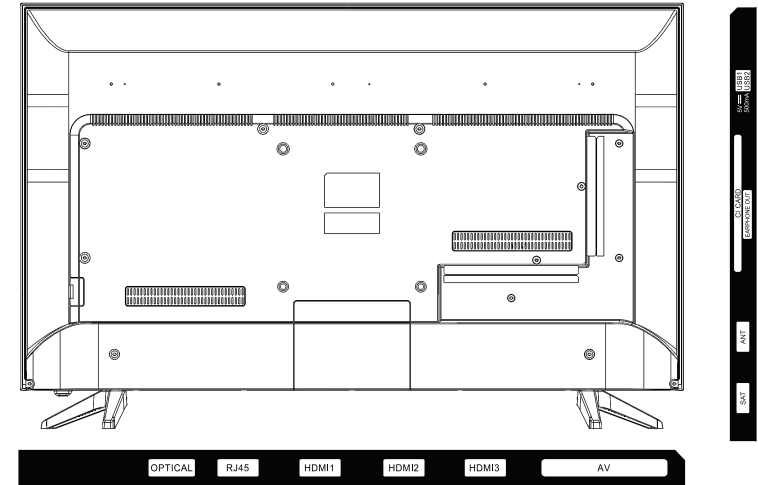

Optical Out: Digital Audio Output from TV

RJ45: Ethernet/LAN input from Router to TV

HDMI1/HDMI2/HDMI3: Connect HDMI input signal from signal source such as DVD

AV In: Connect Audio and Video input signal from source such as DVD

SAT: Connect RF signal from satellite/DVB-S

ANT: Connect Analog/ATV signal or Digital/ DVB-T or DVB-C signal

CI Slot: Insert CI card for Digital TV

Earphone Out: Audio Output from TV through Earphone

USB1/USB2: USB support multimedia playback and software upgrade

EXTERNAL SCHEMATIC AND INSTALLATION

Antenna/Cable Connection

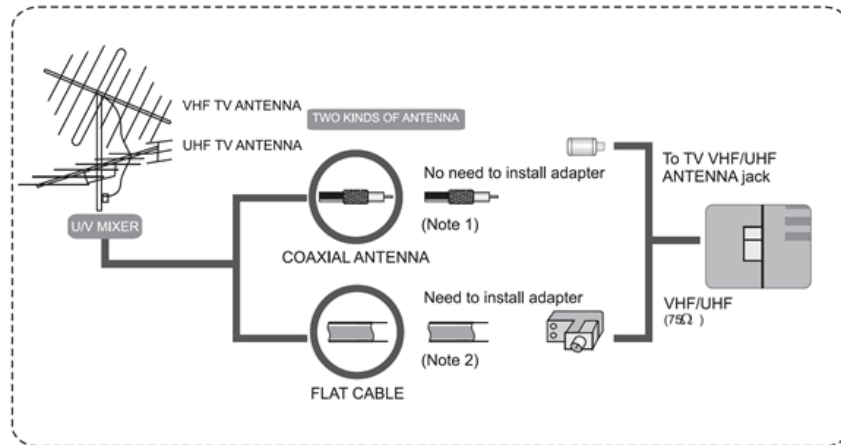

- Connect the Plug of the antenna cable or CATV cable to the cable (not provided with this unit), then connect to the antenna input of this unit for best reception.
- If the antenna cable in your home is other than the above two or you have problems in installing the antenna, please contact your dealer.

Notes:

- Current outdoor antenna or cable TV use 75 OHM coaxial antenna cable. For better reception suggest this kind of antenna cable
- Flat cable or indoor antenna are old designed, the reception may not be good enough

REMOTE CONTROLLER

- : Turn on the TV or enter standby mode
- : Turn off the sound and turn on when press again
- 0 ~ 9 : Figures 0-9 are used to directly input channel number
- : Press to display Electronic Program Guide and select the favorite channel
- : Press to enter Teletext when play the program
- : Input source selection button
- : Press to enter the Home Page
- V+: Increase the volume
- V-: Decrease the volume
- P+: Increase the program
- P-: Decrease the program
- : Start system menu
- : Press to display the source and channels display
- : To confirm the choice with the highlighted menu item
- : Press these buttons to select items
- : Press these buttons to select and adjust items
- BACK: Go back to the previous step
- EXIT: Press to exit the OSD menu
- NETFLIX: Press to launch the Netflix
- YouTube: Press to launch the YouTube
- : Press to launch NetRange app store
- : Press to enter USB mode
- GREEN/RED/YELLOW/CYAN button: Press these buttons according to different prompts
- : Press to fast reverse in USB mode
- : Press to fast forward in USB mode
- : Press to play the video and press again to pause the video
- : Press to start recording the program
- : Hold on or off for current page display
- : Press to change the language when palying the stream which contains multi-language



SOURCE

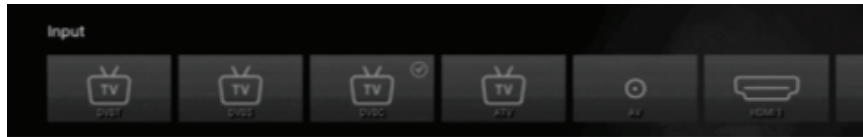

- 1). Press the button on the remote control to display the Input source menu bar.
- 2). Press the buttons to select the input source that you want: **DVBT / DVBS / DVBC / ATV / HDMI 1 / HDMI 2 / HDMI 3 / USB / HOME.**
- 3). Press the **OK** button to confirm your selection. If you do not press the **OK** button to confirm, the TV will automatically confirm the selected input source within few seconds.

BASIC OPERATION

Initial Setup

Choosing Your OSD Language

The first time you switch your TV on, it will automatically be in the initial setup mode. This will guide you through the whole setup process of selecting your desired language, connecting to the internet, signing in to your account and tuning in TV channels.

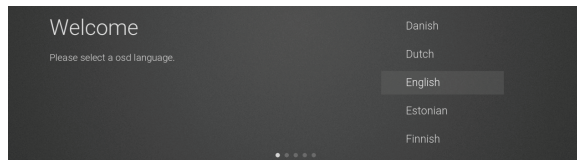

- 1). Press the buttons to highlight your desired OSD language then press the **OK** button.
- 2). Data Collection and Firmware Updates Notice page will appear. Press the buttons to select the menu option.

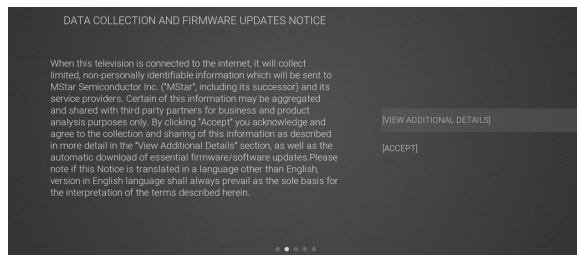

VIEW ADDITIONAL DETAILS

Go to view more detailed firmware/software network download update instructions.

BASIC OPERATION

ACCEPT

Accept all agreements and agree to the firmware/software network to automatically download updates

- 3). If you select **VIEW ADDITIONAL DETAILS**, the detailed firmware/software network download update instructions will display. Initially, the default focus will be on the text description section. Press the buttons will drop the text to the bottom. Press the buttons, **ACCEPT ALL** will highlight. Press the buttons then the **OK** button to confirm the selection.

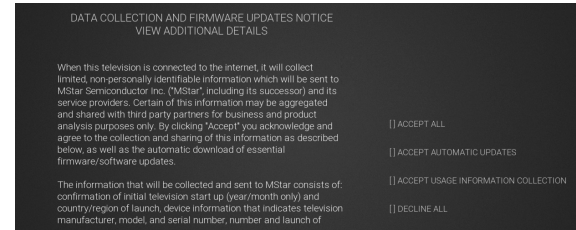

ACCEPT ALL

Accept all protocol sections and agree to the firmware/software network to automatically download updates.

ACCEPT AUTOMATIC UPDATES

Accept all protocol parts and manually select whether to agree to the firmware/software network download update if there is a firmware/software update.

ACCEPT USAGE INFORMATION COLLECTION

Suppliers accepting the agreement section collect some non-personal user information.

DECLINE ALL

Reject all protocols to disable firmware/software network updates.

- 4). Press the buttons to select your country where you will operate the TV. Press the **OK** button to confirm.

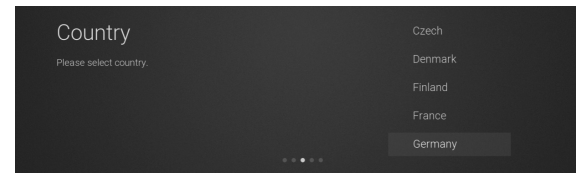

Connecting to the Internet

You have 2 options when connecting your TV to the internet. You can connect wirelessly via Wi-Fi or connect your TV to your router directly by connecting a LAN cable (wired connection). Choose your connection method and follow these instructions.



Wi-Fi Network

- 1). Press the buttons to highlight Wi-Fi Network then press the **OK** button. Your TV will automatically scan for your wireless network, then show you a list of networks that it's found. Highlight your network and press the **OK** button.

BASIC OPERATION

2). Use the ◀▶ buttons to navigate the keypad in the screen to enter your Wi-Fi password, then press the **OK** button to select the characters. Finally select the → and press the **OK** button. In a second or two your TV will show **Success** after connection successful.

WIRED Connection

If you have connected your Ethernet cable to the LAN socket on the back of your TV, select **Wired Network** and then press the **OK** button. Then select **Connect** to start connect to the internet.

SKIP Connection

1). If you do not need to connect to the network, select **Skip** and press the **OK** button to confirm.

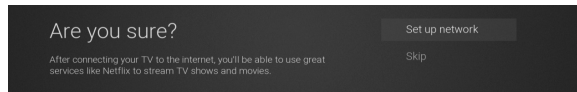

2). A pop up menu will be display. If you want to go back the network setting page, select **Set up Network**. If you want to confirm to skip the network setting, select **Skip**. Then will enter to **Input Source** menu and start TV Tuning.

Signing in to Your Netflix Account

Press the ▲▼ buttons to select **Start Netflix** then press the **OK** button. You will now be asked to sign in to your Netflix account. If you don't already have an account you can set one up on your TV go to the '**Join Now**' section.



If you want to temporary skip the Netflix setting, select **Skip** to enter to **Input Source** menu and start TV Tuning.

If you complete Netflix setting, press the **EXIT** button to leave and press the ⚙ button and select **Programme**, then select **Auto Tuning** for TV tuning.

Tuning in Your TV

If you select **Skip** option in **Netflix** setting page, then you now need to tune in your TV so that you can watch LIVE TV (broadcast TV). If you watch TV via a Set Top Box you can skip this section by selecting the correct HDMI input source.

BASIC OPERATION

DVB-T

1) **Input Source** page shown on the TV, use the ▲▼ buttons to select **TV**. Then press the **OK** button.

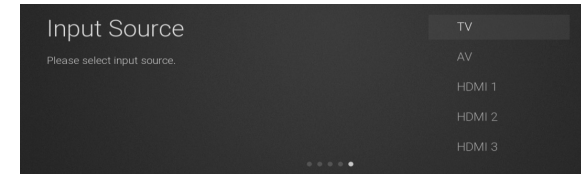

2) In **DVB Tuning Type** page, use the ▲▼ buttons to select **DVB-T**.

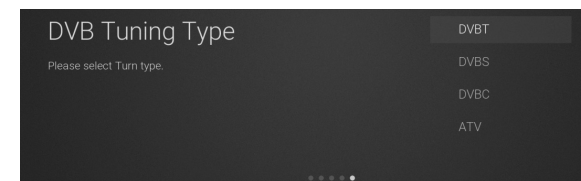

3) Your TV will now start scanning for all the available TV channels. This operation may take a few minutes. The display will show the progress of the tuning and the number of channels found.

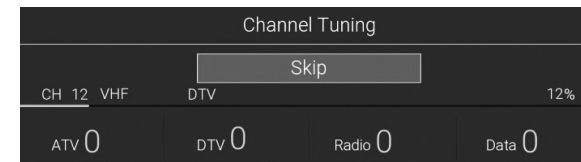

4) If you want to skip the DTV tuning, press the **OK** button to interrupt the tuning half way. A pop-up screen will be displayed, press the ◀ button to select **YES** to confirm.
e. Your TV is now setup and ready to watch.

DVB-S

1). **Input Source** page shown on the TV, use the ▲▼ buttons to select **TV**. Then press the **OK** button.

2). In **DVB Tuning Type** page, use the ▲▼ buttons to select **DVBS**.

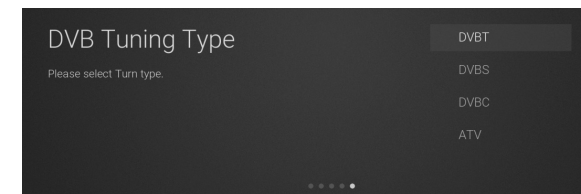

3). **Auto Tuning** window will be displayed. use the ▲▼ buttons to select options. Press the **OK** button and then press the ◀▶ buttons to adjust each option's setting. Press the **OK** button to confirm.

BASIC OPERATION

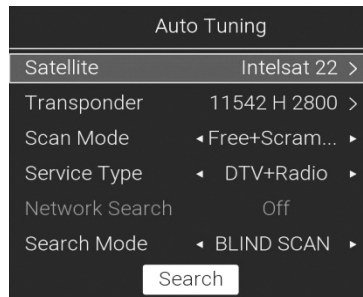

Satellite

Selects your desired satellite.

Transponder

Selects your desired frequency.

Scan Mode

Selects your desired watching channel type: **Free + Scramble / Free / Scramble.**

Service Type

Selects the channel service type: **DTV + Radio / Radio / DTV.**

Network Search

Whether to perform Network Quick Search (**Search Mode** is optional for **FAST SCAN**)

Search Mode

Selects the scanning method: **BLIND SCAN / FAST SCAN.**

Search

Starts searching.

4). Your TV will now start scanning for all the available TV channels. This operation may take a few minutes. The display will show the progress of the tuning and the number of channels found.

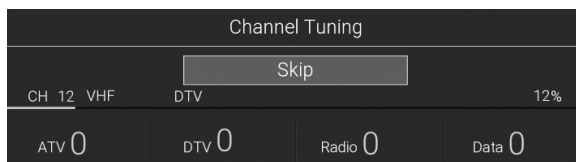

5). If you want to skip the DTV tuning, press the **OK** button to interrupt the tuning half way. A pop-up screen will be displayed, press the **◀** button to select **YES** to confirm.

6). Your TV is now setup and ready to watch.

DVB-C

1). **Input Source** page shown on the TV, use the **▲▼** buttons to select **TV**. Then press the **OK** button.

2). In **DVB Tuning Type** page, use the **▲▼** buttons to select **DVBC**.

BASIC OPERATION

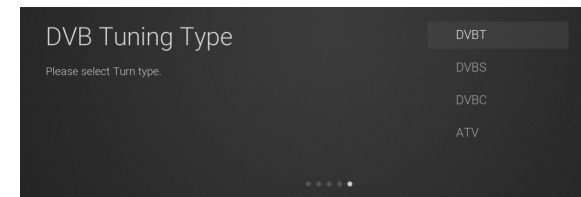

3). Your TV will now start scanning for all the available TV channels. This operation may take a few minutes. The display will show the progress of the tuning and the number of channels found.

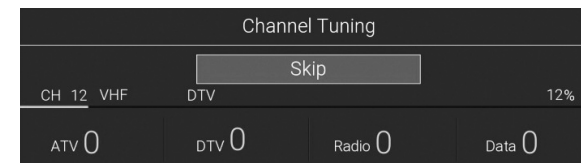

4). If you want to skip the tuning, press the **OK** button to interrupt the tuning half way. A pop-up screen will be displayed, press the **◀** button to select **YES** to confirm.

5). Your TV is now setup and ready to watch.

HOME Menu

1). Press the **🏠** button to display the home menu.

2). Use the **▲▼** buttons to switch between the **Apps**, **NETFLIX**, **Input**, and **Settings** sections of the Home page.

3). Use the **◀▶** buttons to select the desired App, Input source or Setting, then press the **OK** button to confirm.

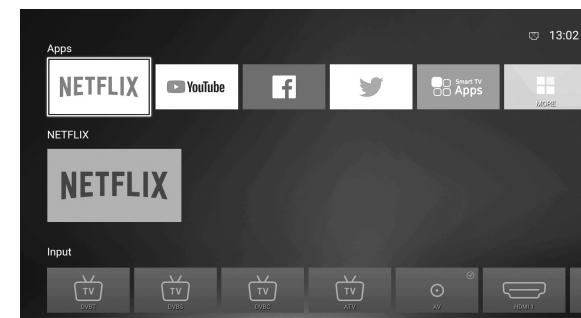

Setting

Allows you to set various performance of your TV.

1). Press the **⚙️** button to display the main menu.

2). Press the **▲▼** buttons to select **Setting** menu and then press the **OK** button.

BASIC OPERATION

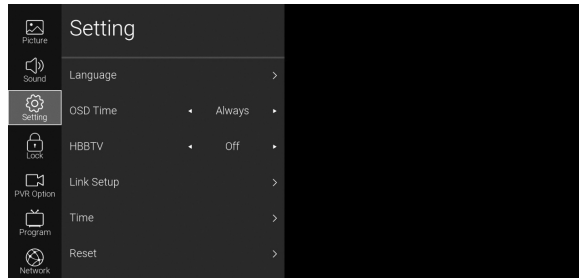

3). Press the ▲▼ buttons to select following setting options. Press the OK button and then press the ◀▶ buttons to adjust each option's setting.

Language

OSD Language

Allows you to select your desired On Screen Display language.

Audio Language

Allows you to select your desired audio language. (Available for digital channels if multiple audio languages are broadcast)

Press the OK button to enter the submenu to select **Primary** and **Secondary** audio language.

Subtitle Language

Allows you to select your desired subtitle language or turn off the subtitle. (Available for digital channels if multiple subtitle languages are broadcast)

Press the OK button to enter the submenu then use the ◀▶ buttons to switch **On** or **Off** on **Subtitle**, select **Primary** and **Secondary** subtitle language, and switch **On** or **Off** on **Hearing Impaired**.

OSD Time

You can select a time that your on-screen menu will be displayed: **5 / 10 / 15** Seconds / **Always**. If you select **Always**, the menu will remain on the screen until you press a button to remove it.

HBBTV

HbbTV (Hybrid broadcast broadband TV) is a service offered by certain broadcasters and available only on some digital TV channels. HbbTV delivers interactive television over broadband Internet.

To use HbbTV please ensure your TV is connected to Internet and HbbTV is switched on.

Link Setup

Allows you to command and control two or more CEC-enabled devices, that are connected

BASIC OPERATION

through HDMI, by using only one of the remote controls (e.g. controlling a TV set, set-top box and DVD player using only the remote control of the TV). CEC also allows individual CEC-enabled devices to command and control each other without user intervention.

Make sure that your CEC-compliant device is connected to your TV using a HDMI cable and the correct HDMI input source is selected prior to using this function. (Some HDMI cables may not support HDMI-CEC functions.)

HDMI - CEC

Allows you to control other CEC enabled devices (connected via HDMI) using your TV remote control.

HDMI ARC

When **HDMI - CEC** is set to **On**, press the ◀▶ buttons to select **On** to enable to send audio to CEC-compliant audio devices or select **Off** to disable the function.

Auto Power

When **HDMI - CEC** is set to **On**, press the ◀▶ buttons to select **On** to enable to set CEC-compliant devices to auto power off.

Auto Standby

When **HDMI - CEC** is set to **On**, press the ◀▶ buttons to select **On** to enable to set TV auto power on if an CEC-compliant devices is switch on.

Time

Allows to set the time and date manually or set automatically when receiving a digital signal.

Auto Sync

If **Auto Sync** is set to **On**, the time and date will be set from the broadcast signal.

If you want to set the time and date manually, set **Auto Sync** to **Off**.

Clock

When **Auto Sync** is set to **Off**, press the ▲▼ buttons to enter the **Clock** page. Use the ◀▲▼▶ buttons set **Year / Month / Day / Hour / Minute**.

Off Time

Allows you to set the shutdown time. Press the OK button to enter **Off Time** page. Use the ◀▲▼▶ buttons set the options: **Off Time Mode / Hour / Minute**.

On Time

Allows you to set the boot up time. Press the OK button to enter **Off Time** page. Use the ◀▲▼▶ buttons set the options: **Off Time Mode / Hour / Minute / Source**.

BASIC OPERATION

Sleep Timer

The sleep timer automatically switches the TV to standby after the preset time has elapsed. The clock will be set automatically when receiving a digital signal. Time must be set before using Sleep Timer function.

Press the ◀▶ buttons to select a period of time after which the TV automatically switches to standby mode: OFF / 10 / 20 / ... / 180 / 240 min. The timer begins to count down from the number of minutes selected.

Auto Sleep

If **Auto Sleep** is set to **On**, the unit will automatically switch to standby mode **4 hours** after the last time the remote control was used. A reminder screen will pop up and count down before the unit switches to standby mode.

Time Zone

When you select a time zone city, the TV time is set by the time offset information based on Time Zone and GMT (Greenwich Mean Time) which is received with the broadcast signal and the time is set automatically by a digital signal.

Environment

Allows you to select **Home mode** to maximize energy efficiency or **Shop mode** if you would like your picture to be brighter.

Reset

Restores all settings to the factory defaults.

4). Press the **BACK** button to return to the previous menu. Press the **EXIT** button to exit the menu.

Picture

Allows you to set your preferred picture mode.

1). Press the  button to display the main menu.

BASIC OPERATION

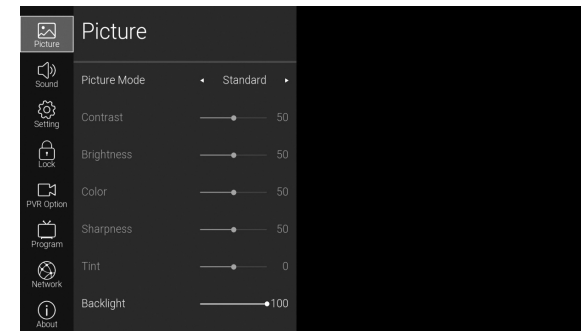

2). Press the ▲▼ buttons to select **Picture** menu and then press the **OK** button.

3). Press the ▲▼ buttons to select following picture options. Press the **OK** button and then press the ◀▶ buttons to adjust each option's setting.

Picture Mode

Select among picture mode: **Standard / Movie / User / Dynamic**.

Contrast

Adjusts the difference between light and dark levels in the picture (for **User** mode).

Brightness

Increases or decreases the amount of white in the picture (for **User** mode).

Color

Controls the color intensity (for **User** mode).

Sharpness

Adjusts the level of crispness in the edges between light and dark areas of the picture (for **User** mode).

Tint (For NTSC format)

Adjusts the balance between red and green levels (Tint is only available for ATV mode or NTSC signal reception).

Backlight

Adjusts the backlight setting of your TV. This controls the brightness and display performance of the screen.

Color Temperature

Select among color temperature: **Standard / Warm / Cool**.

Aspect Ratio

Allows you to watch the screen in various picture formats: **16:9 / Movie / Subtitle / 4:3**. Different screen adjustment options are displayed depending on the current input source.

Noise Reduction



Select to reduce the noise level of the connected device: **Off / Low / Middle / High / Auto**.

4). Press the **BACK** button to return to the previous menu. Press the **EXIT** button to exit the menu.





BASIC OPERATION

Sound

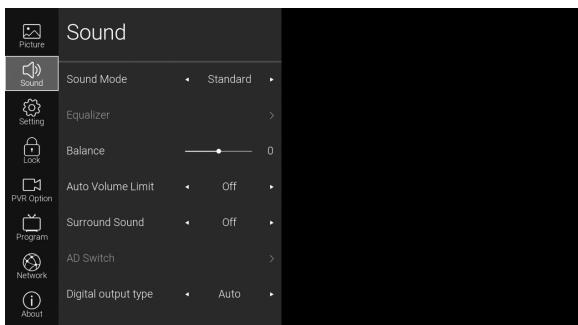

Allows you to select an audio-enhancement technique.

- 1). Press the  button to display the main menu.
- 2). Press the   buttons to select **Sound** menu and then press the **OK** button.



- 3). Press the   buttons to select following sound options. Press the **OK** button and then press the   buttons to adjust each option's setting.

Sound Mode

You can select this function when surround sound switch off. Press the   buttons to select an audio-enhancement technique: **Standard / Music / Movie / Sport / User**.

Equalizer (for User mode)

Adjusts the sound by raising or lowering the level of specific frequency from 0-100: 120Hz / 500Hz / 1.5KHz / 5KHz / 10KHz.

Balance

Adjusts the relative volume of the speakers in a multiple speaker system.

Auto Volume Limit

Volume levels are automatically controlled (e.g., advertisements tend to be louder than the Programs).



Surround Sound

Delivers an immersive virtual surround sound experience over front facing speaker configurations, complete with Rich Bass, High Frequency Detail and Clear Dialogue.

AD Switch (for DTV mode)

Audio Description is an auxiliary audio function that provides an additional audio track for visually challenged persons. This function handles the Audio Stream for the AD (Audio Description), when it is sent along with the main audio from the broadcaster.

BASIC OPERATION

- Set to “**Off**” for normal broadcasting sound coming out from speakers.
- Set to “**On**” to activate the description sound track if available. Press the   buttons to adjust the AD volume. The availability of Audio Description sound track is indicated by the visually impaired icon “**V.I.**” in the information banner.

Digital Output Type

Selects the type of digital audio output: **Auto / Dolby DD / Dolby DD+ / PCM**.

Audio Type (for DTV mode)

Selects the type of audio output: **Normal / Hearing Impaired / Visual Impaired**.

Audio Delay



Adjusts the audio delay setting from 0-250: **SPDIF Delay / Speaker Delay / HDMI ARC Delay**.

- 4). Press the **BACK** button to return to the previous menu. Press the **EXIT** button to exit the menu.





Programme

Auto Tuning (DTV Mode)

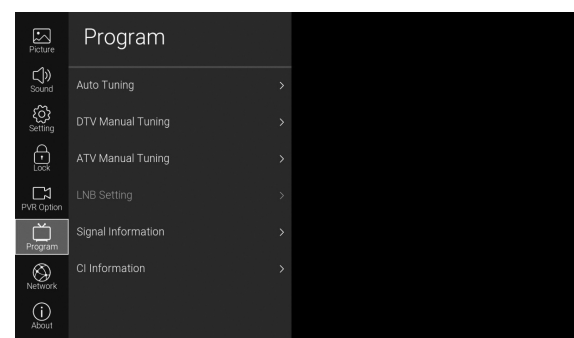
Use this to automatically find and store all available channels. This is normally recommended if some channels have been added or removed by the broadcaster or if you have moved.

- 1). Press the  button to display the main menu.
- 2). Press the   buttons to select **Programme** menu and then press the **OK** button.



- 3). Press the   buttons to select **Auto Tuning** menu and then press the **OK** button.
- 4). In the **Auto Tuning** menu, select **Tuning Mode** and then press the   buttons to select **DTV / ATV / DTV+ATV**.

BASIC OPERATION

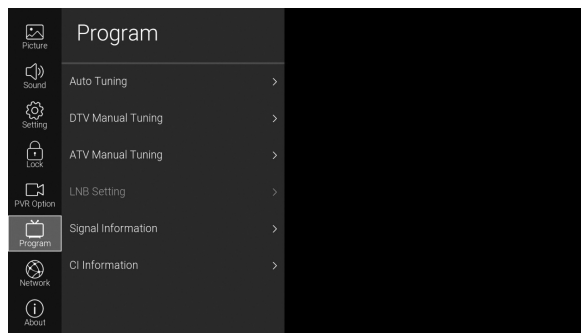

5). Press the ▼ button and then press the ◀▶ buttons to select the country where you will operate the TV. Press the ▼ button.

6). Press the **OK** button to start auto tuning.

7). If the input source is DVB-S, **Auto Tuning** window will be displayed. Use the ▲▼ buttons to select the options, then use the ◀▶ buttons to adjust each option's setting. Press the ▲▼ buttons to select Search and press the **OK** button to start searching.

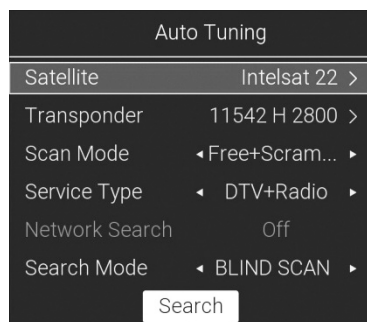

Satellite

Selects your desired satellite.

Transponder

Selects your desired frequency.

Scan Mode

Selects your desired watching channel type: **Free + Scramble / Free / Scramble**.

Service Type

Selects the channel service type: **DTV + Radio / Radio / DTV**.

Network Search

Whether to perform Network Quick Search (**Search Mode** is optional for **FAST SCAN**)

BASIC OPERATION

Search Mode

Selects the scanning method: **BLIND SCAN / FAST SCAN**.

Search

Start searching.

8). Your TV will now start scanning for all the available TV channels. This operation may take a few minutes. The display will show the progress of the tuning and the number of channels found.

9). If you select DTV+ATV mode and want to skip the DTV tuning, press the **OK** button to interrupt the tuning half way. A pop-up screen will be displayed, press the ◀ button to select **YES** to confirm. You will then go straight to ATV tuning. You may repeat the above step if you also want to skip the ATV tuning.

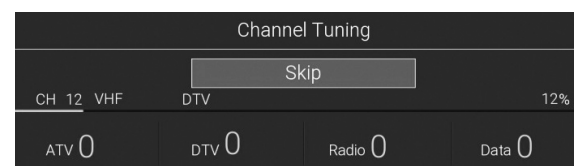

10). Your TV is now setup and ready to watch.

DTV Manual Tuning (DVB-T Mode)

Allows you to make manual fine tuning adjustments to the channel under DTV mode.

1). Press the ⚙ button to display the main menu.

2). Press the ▲▼ buttons to select **Programme** menu and then press the **OK** button.

3). Press the ▲▼ buttons to select **DTV Manual Tuning** menu and then press the **OK** button.

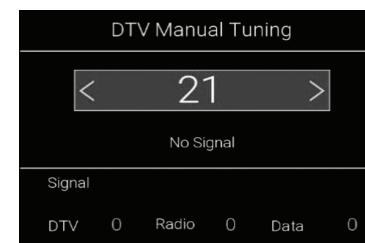

4). The **DTV Manual Tuning** screen will pop up. Press the ◀▶ buttons to select the desired VHF channel and then press the **OK** button to commence the search of that channel. When the signal has been tuned, the picture and signal strength will be displayed on the screen.

5). Press the **BACK** button to return to the previous menu. Press the **EXIT** button to exit the menu.

BASIC OPERATION

DTV Manual Tuning (DVB-S Mode)

Allows you to make manual fine tuning adjustments to the channel under DTV mode.

- 1). Press the  button to display the main menu.
- 2). Press the **▲▼** buttons to select **Programme** menu and then press the **OK** button.
- 3). Press the **▲▼** buttons to select **DTV Manual Tuning** menu and then press the **OK** button.

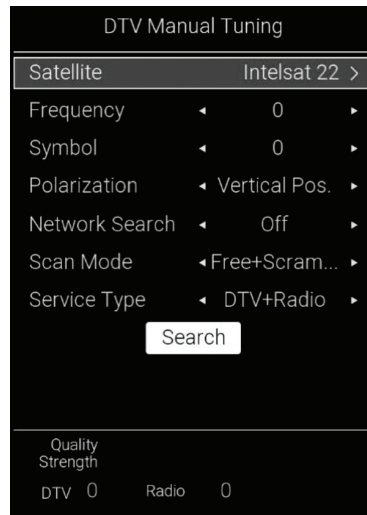

- 4). The **DTV Manual Tuning** screen will pop up, use the **▲▼** buttons to select the options, then use the **◀▶** buttons to adjust each option's setting. Press the **▲▼** buttons to select **Search** and press the **OK** button to start searching.

Satellite

Selects your desired satellite.

Frequency

Selects the frequency.

Symbol

Selects the symbol.

Polarization

Selects the type of polarization.

Network Search

Whether to perform Network Quick Search.

BASIC OPERATION

Scan Mode

Selects your desired watching channel type: **Free + Scramble / Free / Scramble**.

Service Type

Selects the channel service type: **DTV + Radio / Radio / DTV**.

Search

Start searching.

- 5). When the signal has been tuned, the picture and signal strength will be displayed on the screen.

- 6). Press the **BACK** button to return to the previous menu. Press the **EXIT** button to exit the menu.

DTV Manual Tuning (DVB-C Mode)

Allows you to make manual fine tuning adjustments to the channel under DTV mode.

- 1). Press the  button to display the main menu.
- 2). Press the **▲▼** buttons to select **Programme** menu and then press the **OK** button.
- 3). Press the **▲▼** buttons to select **DTV Manual Tuning** menu and then press the **OK** button.
- 4). The **CADTV** screen will pop up, use the **▲▼** buttons to select the options, then use the **◀▶** buttons to adjust each option's setting. Press the **▲▼** buttons to select **Search** and press the **OK** button to start searching.

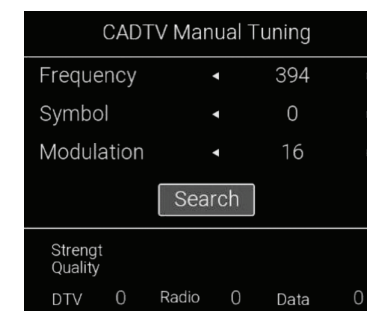

Frequency

Selects the frequency.

BASIC OPERATION

Symbol

Selects the symbol.

Modulation

Selects the modulation.

5). When the signal has been tuned, the picture and signal strength will be displayed on the screen.

6). Press the **BACK** button to return to the previous menu. Press the **EXIT** button to exit the menu.

ATV Manual Tuning (ATV Mode)

Allows you to make manual fine tuning adjustments if the channel reception is poor under **ATV** mode.

- 1). Press the  button to display the main menu.
- 2). Press the **▲▼** buttons to select **Programme** menu and then press the **OK** button.
- 3). Press the **▲▼** buttons to select **ATV Manual Tuning** menu and then press the **OK** button.
- 4). The **ATV Manual Tuning** screen will pop up, use the **▲▼** buttons to select the options, then use the **◀▶** buttons to adjust each option's setting. Press the **▲▼** buttons to select **Search** and press the **OK** button to start searching.

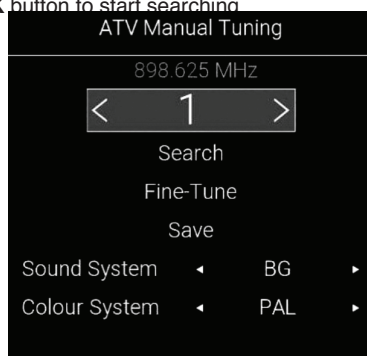

Current Channel

Displays the current channel number.

BASIC OPERATION

Search

Press to start the manual tuning.

Fine-Tune

Press to make manual fine tuning adjustments.

Save

Save the setting.

Sound System

Selects the sound system: **BG / I / DK / L / M**.

Color System

Selects the color system: **PAL / SECAM / NTSC**.

- 5). After searching, Press the **▲▼** buttons to select **Save** and the **OK** button to confirm.
- 6). Press the **BACK** button to return to the previous menu. Press the **EXIT** button to exit the menu.

LNB Setting (DVB-S Mode)

Allows you setup your satellite. The Low Noise Block down Converter (LNB) amplifies the signal received by the satellite dish and lowers the frequency of the signal.

- 1). Press the  button to display the main menu.
- 2). Press the **▲▼** buttons to select **Programme** menu and then press the **OK** button.
- 3). Press the **▲▼** buttons to select **LNB Setting** menu and then press the **OK** button.
- 4). The **LNB Setting** screen will pop up, use the **▲▼** buttons and the **OK** button to select the options, then use the **◀▶** buttons to adjust each option's setting. Press the **BACK** button to return to previous menu.

BASIC OPERATION

LNB Setting	
Satellite	Intelsat 22 >
Transponder	11542 H 02800 >
LNB Power	◀ 13/18V ▶
Low/High Freq	Universal >
22kHz Tone	◀ Auto ▶
Toneburst	◀ None ▶
DiSEqC1.0	◀ None ▶
DiSEqC1.1	◀ None ▶
Motor	◀ None ▶
SingleCable	None >
Quality Strength	

Satellite

Selects your desired satellite.

Transponder

Selects your desired frequency.

LNB Power

Select LNB power on to output LNB voltage.

Low/High Freq

Select the low and high frequency of LNB.

22kHz Tone

Depending on the satellite switch box or LNB. When selecting the U-LNB 1 and U-LNB 2, the 22KHz will be dimmed. (MOTOR DiSEqC 1,2).

Toneburst

Depending on the user's antenna switch box: **None / BurstA / BurstB**.

DiSEqC1.0

The TV is designed to be DiSEqC 1.0 compatible. Select one of LNB1 to LNB4 or Disable according to the option or the configuration of DiSEqC switch box or antenna.

DiSEqC1.1

The TV is designed to be DiSEqC 1.1 compatible. Select one of LNB1 to LNB16 or Disable

BASIC OPERATION

according to the option or the configuration of DiSEqC switch box or antenna.

Motor

Select **DiSEqC1.2** or **DiSEqC1.3** then press the colored button to enter the submenu. Then use the ◀▲▼▶ buttons to advance settings.

SingleCable

Select and control of plural Satellite antennas through the combined single antenna cable. Use the ◀▲▼▶ buttons to advance settings.

5). Press the **BACK** button to return to the previous menu. Press the **EXIT** button to exit the menu.

Signal Information (DTV Mode)

Allows you to view the signal information.

- 1). Press the  button to display the main menu.
- 2). Press the ▲▼ buttons to select **Programme** and then press the **OK** button.
- 3). Press the ▲▼ buttons to select **Signal Information** and then press the **OK** button to view the signal information.

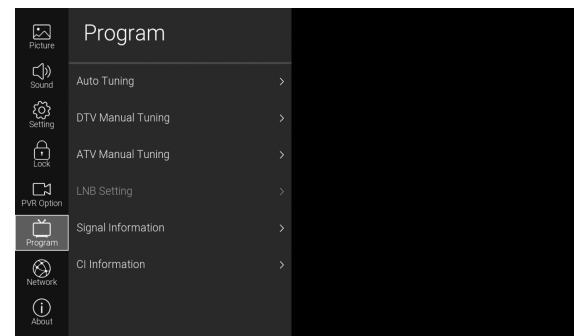

4). Press the **BACK** button to return to the previous menu. Press the **EXIT** button to exit the menu.

CI (Common Interface) (DTV Mode)

The common interface allows the use of a Common Access Module to enable you to view scrambled (pay to view) services. These services are provided by TopUp TV (UK only) and others. The Common Access Module and viewing card can be obtained from the service provider.

To insert the Common Access Module

- 1). Before you insert the Common Access Module, ensure that the TV is switched off and the viewing card is inserted **in accordance with the Service Provider's instructions**.

BASIC OPERATION

2). Insert the Common Access Module into the slot. Flip the Common Access Module to another side and try again if you feel resistance.

3). Switch the TV on.

To view the module information

- 1). Press the  button to display the main menu.
- 2). Press the **▲▼** buttons to select **Programme** menu and then press the **OK** button.
- 3). Press the **▲▼** buttons to select **CI Information** menu and then press the **OK** button to view CI information.

Lock

To access the **LOCK** menu, you must enter the password. Enter the default password "0000" for first time use. To change the password, please refer to the section "**Set Password**".

Lock System

The **Lock System** is designed to prevent accidental re-tuning of the TV / losing of channels and to prevent children from watching unsuitable programs.

The **Lock System** must be set to **On** for this function to operate. If the **Lock System** is set to **On**, a valid password must be entered when you access **Auto Tuning / Manual Tuning / LNB Setting / Reset**.

- 1). Press the  button to display the main menu.
- 2). Press the **▲▼** buttons to select **Lock** menu and then press the **OK** button.

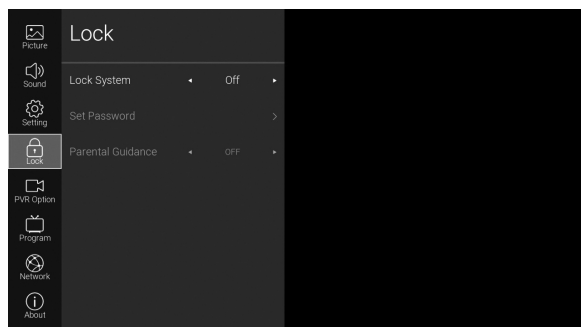

- 3). Use the **0-9** buttons to input a 4-digit password to enter the **LOCK** menu.
- 4). Press the **OK** button to select **Lock System**.
- 5). Press the **▲▼** buttons to select **Lock System** and then the **◀▶** buttons to select **On / Off**. If the **Lock System** is set to **On**, a valid password must be entered when you access **Auto Tuning / Manual Tuning / LNB Setting / Reset**.

BASIC OPERATION

6). Press the **BACK** button to return to the previous menu. Press the **EXIT** button to exit the menu.

Set Password

- 1). Press the  button to display the main menu.
- 2). Press the **▲▼** buttons to select **Lock** menu and then press the **OK** button.

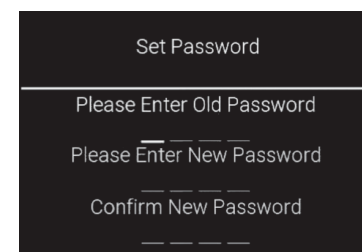

- 3). Use the **0-9** buttons to input a 4-digit password to enter the **LOCK** menu.
- 4). Press the **OK** button to select **Lock System**.
- 5). Press the **▲▼** buttons to select **Lock System** and then press the **◀▶** buttons to select **On**.
- 6). Press the **▲▼** buttons to select **Set Password** and then press the **OK** button.
- 7). Use the **0-9** buttons to input the old password and then input the new 4-digit password. Re-enter new password for confirmation.
- 8). Press the **BACK** button to return to the previous menu. Press the **EXIT** button to exit the menu.

Parental Guidance

This function allows you to set up blocking schemes to block specific channels and ratings. It operates according to information from the broadcasting station, therefore if the signal has incorrect information, this function will not operate.

This TV is programmed to remember the last option set even if the TV is switched off. When a programme is locked or rated, a valid password must be entered.

- 1). Press the  button to display the main menu.
- 2). Press the **▲▼** buttons to select **Lock** menu and then press the **OK** button.

BASIC OPERATION

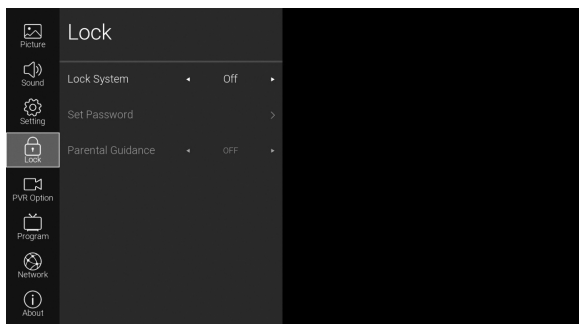

- 3). Use the **0-9** buttons to input a 4-digit password to enter the **LOCK** menu.
- 4). Press the **OK** button to select **Lock System**.
- 5). Press the **▲▼** buttons to select **Lock System** and then press the **◀▶** buttons to select **On**.
- 6). Press the **▲▼** buttons to select **Parental Guidance**.
- 7). Press the **◀▶** buttons to select an age rating: **Off, 4-18**.
- 8). Press the **BACK** button to return to the previous menu. Press the **EXIT** button to exit the menu.

. The default password is "0000".

. If you change the password, be sure to remember the new password! If you forget the new password, enter the master password "8899".

PVR Option (DTV Mode)

Allows you to set your preferences in the PVR File System, PVR recording and Timeshift.

- 1). Press the  button to display the main menu.
- 2). Press the **▲▼** buttons to select **PVR Option** menu and then press the **OK** button.

BASIC OPERATION

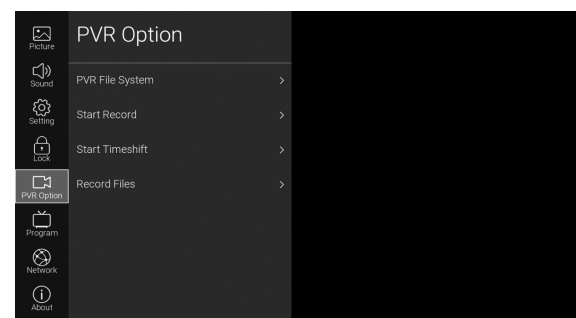

- 3). Press the **▲▼** buttons to select following setting options. Press the **OK** button and then press the **◀▶** buttons to adjust each option's setting.

PVR File System

Allows you to select your preferences in the PVR File System.

Select Disk

Selects the disk where you want to store your recorded content.

Select Partition

Selects disk partition where the recorded file is supposed be saved.

Time Shift Size

Selects the format size of the disk for Time Shift.

Format

Start formatting the disk.

Speed

This shows the transfer rate of your USB storage device.

Start Record

Start PVR Recording.

Start Timeshift

Start Timeshift.

Record Files



Views the recorded programs in the **Recorded List**.

- 4). Press the **BACK** button to return to the previous menu. Press the **EXIT** button to exit the menu.





BASIC OPERATION

Network

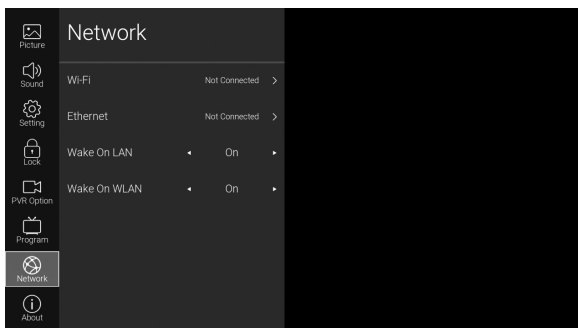
Adjust all your network setting and check your connection if you are having connection problems.

- 1). Press the  button to display the main menu.
- 2). Press the   buttons to select **Network** and then press the **OK** button.



- 3). Press the   buttons to select following setting options. Press the **OK** button and then press the   buttons to adjust each option's setting.

Wi-Fi

The built-in wireless LAN device allows you to access the Internet and enjoy the benefits of Networking in a cable-free environment.

Auto Scan

The TV will automatically scan and show all available wireless networks in the area. Choose the desired network and press the **OK** button, then enter Network Security Key.

Manual Input

Choose to manually setup Static IP information.

Manual Setup is only for advanced users and network where the network client devices need specific setting to access the network.

IP

Display the connected wireless network IP address.

Netmask

Display the connected wireless network subnet mask.

Gateway

Display the connected wireless network gateway.

BASIC OPERATION

DNS

Display the connected wireless DNS.

Ethernet

Connect your TV to your network by connecting the LAN port on the back of your TV to an external modem or router using a LAN (Ethernet/Cat 5) cable.

Protocol

Select wired network protocol: **IPv4 / IPv6**.

Configuration

Select wired network IP acquisition method: **DHCP / Static**.

IP

Set the wired network IP address. (Configuration is set to Static)

Prefix

Set the number of bits in the wired network subnet mask. (Configuration is set to Static)

Gateway

Set the wired network gateway. (Configuration is set to Static optional)

DNS

Set the wired network DNS. (Configuration is set to Static optional)

Connect

Connect to a wired network.

Wake On LAN

Turn on / off the TV wake-on-LAN.

Wake on WLAN

Turn on / off the TV wake-on-WLAN.

BASIC OPERATION

Other Information

- 1). Press the  button to display the main menu.
- 2). Press the **▲▼** buttons to select **About** and then press the **OK** button.

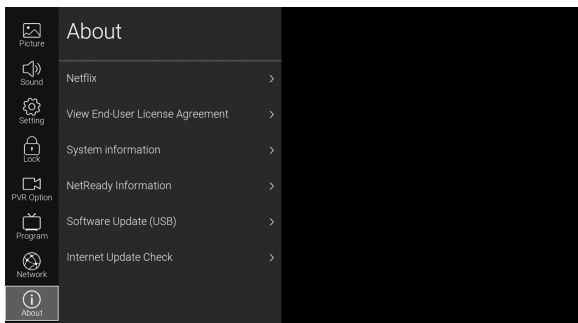

- 3). Press the **▲▼** buttons to select following setting options. Press the **OK** button and then press the **◀▶** buttons to adjust each option's setting.
- 4). Press the **BACK** button to return to the previous menu. Press the **EXIT** button to exit the menu.

Netflix

Allows to control your Netflix account

Netflix Deactivate

Select **YES** to confirm to clear your Netflix login account.

Terminate Netflix

Select **YES** to confirm to terminate your Netflix.

Netflix ESN

Display your ESN key information.

Netflix Version

Display the Netflix version.

View End-User License Agreement

Display Firmware/Software Network Download Update Agreement Description. You can select **VIEW ADDITIONAL DETAILS** to display more details.

System information

Display your TV system information.

Net Ready Information

Display Net Ready information.

BASIC OPERATION

Software Update (USB)

This function is only for servicing purposes.

Internet Update Check

Check and automatically update the software of NetReady.

Using the Features

EPG (Electronic Programme Guide) (DTV or Radio Mode)

This system has an Electronic Programme Guide (EPG) to help you navigate through all the possible viewing options.

The EPG supplies information such as programme listings, start and end times for all available services. In addition, detailed information about the programme is often available in the EPG (the availability and amount of programme information will vary, depending on the particular broadcaster).

This function can be used only when the EPG information is broadcast by broadcasting companies.

The EPG displays the programme details for the next 7 days.

Switch On / Off EPG

- 1). Press the **EPG** button to switch on EPG.
- 2). Press the **EPG** button or the **EXIT** button again to switch off EPG and return to normal TV viewing.

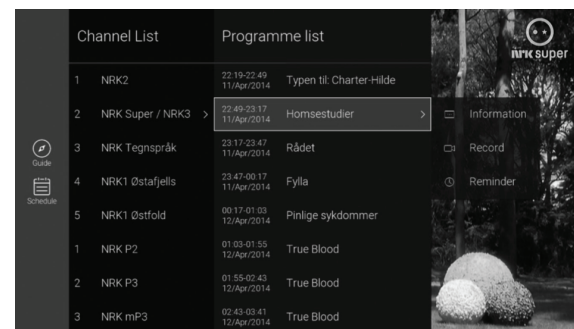

Select a Programme

Press the **▲▼** buttons to select the desired channel and then press the **◀▶** buttons to select the desired programme. Press the **OK** button to confirm.

BASIC OPERATION

Button Functions in a 7-Day Guide

Remote Control Button	Function
▲ or ▼ or ◀ or ▶	Press to select a channel and programme or switch between Schedule and guide menu.
OK	Press to confirm the selection or view the selected programme.
EPG / EXIT	Press to switch off the EPG.

Red Button (Interactive Services) (DTV Mode)

Red button services are available on BBC TV and Radio channels. The services are gradually changing to an internet based service rather than the conventional over air (though your aerial). To make the most out of the Red Button services make sure your TV is connected to the internet.

Accessing the Information

1). In DTV mode, press the  button to display the main information page. You may see slightly different looking pages depending if your TV is accessing the page over air or via the internet.

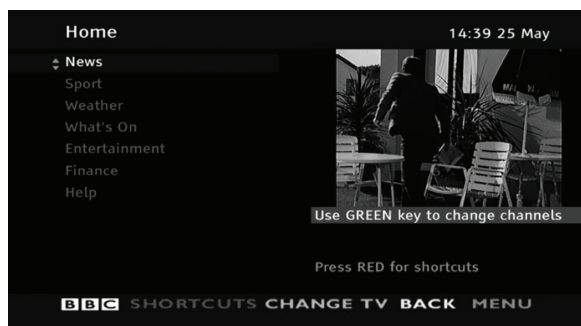

2). Follow the instructions on the interactive services page and move around the page by pressing the ◀▶, OK, RED, GREEN, YELLOW, BLUE or 0-9 buttons etc.

To change digital teletext services, you will need to exit the current text service and change channels. Then enter the text service on the newly selected channel.

3). Press the  button to exit.

MULTIMEDIA OPERATION

Movies

- 1). Press the ▲▼ buttons to select **MOVIE** and then press the **OK** button.
- 2). If you have more than one device connected, press the ◀▶ buttons to select your storage device and then press the **OK** button.
- 3). Press the ◀▶ buttons to navigate in the movie files and then press the **OK** button to view.
- 4). Press the **OK** button to display the function bar. Press the ◀▶ buttons and then press the **OK** button to select the function: Pause (Play) / Prev. / Next / Playlist.
- 5). Press the **EXIT** button to return to the previous menu.

Music

- 1). Press the ▲▼ buttons to select **MUSIC** and then press the **OK** button.
- 2). If you have more than one device connected, press the ◀▶ buttons to select your storage device and then press the **OK** button.
- 3). Press the ◀▶ buttons to navigate in the music files and then press the **OK** button to listen.
- 4). Press the **OK** button to display the function bar. Press the ◀▶ buttons and then press the **OK** button to select the function: Pause (Play) / Prev. / Next / Repeat (Repeat All / Repeat None / Repeat 1) / Playlist.
- 5). Press the **EXIT** button to return to the previous menu.

Photos

1). Press the **SOURCE** button on the TV or on the  button on the remote control to display the **Input Source** bar. Use the ◀▶ buttons to select **USB** and then press the **OK** button to confirm. Press the ▲▼ buttons to select **PHOTO** and then press the **OK** button.



MULTIMEDIA OPERATION

- 2). If you have more the one devices connected, press the ◀▶ buttons to select your storage device and then press the **OK** button.
- 3). Press the ◀▲▼▶ buttons to navigate in the picture files and then press the **OK** button to view.
- 4). Press the **OK** button to display the function bar. Press the ◀▶ buttons and then press the **OK** button to select the function: Pause (Play) / Music / Playlist / Rotate.
- 5). Press the **EXIT** button to return to the previous menu.

ENERGY LABEL

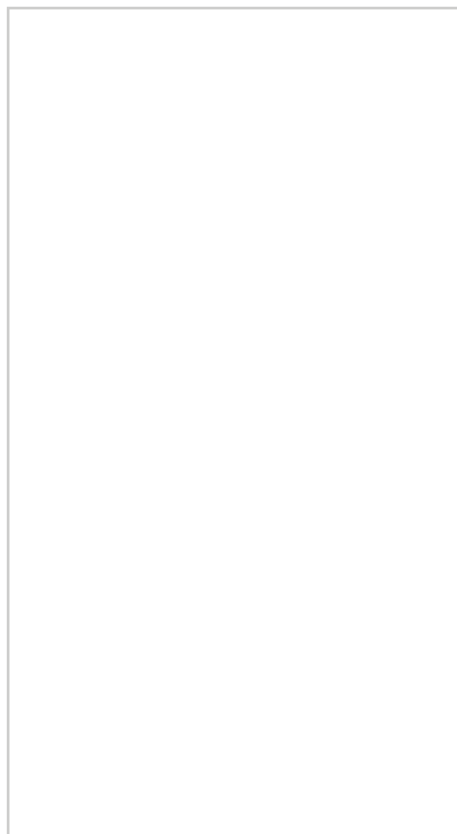

Please notice - All products are subject to change without any notice. We take reservations for errors and omissions in the manual.

ALL RIGHTS RESERVED, COPYRIGHT DENVER ELECTRONICS A/S

DENVER®

www.denver-electronics.com

CE



Electric and electronic equipment and included batteries contains materials, components and substances that can be hazardous to your health and the environment, if the waste material (discarded electric and electronic equipment and batteries) is not handled correctly.

Electric and electronic equipment and batteries is marked with the crossed out trash can symbol, seen above. This symbol signifies that electric and electronic equipment and batteries should not be disposed of with other household waste, but should be disposed of separately.

As the end user it is important that you submit your used batteries to the appropriate and designated facility. In this manner you make sure that the batteries are recycled in accordance with legislature and will not harm the environment.

All cities have established collection points, where electric and electronic equipment and batteries can either be submitted free of charge at recycling stations and other collection sites, or be collected from the households. Additional information is available at the technical department of your city.

Hereby, Inter Sales A/S declares that the radio equipment type LDS-3276 is in compliance with Directive 2014/53/EU. The full text of the EU declaration of conformity is available at the following internet address: www.denver-electronics.com and then click the search ICON on topline of website. Write model number: LDS-3276. Now enter product page, and red directive is found under downloads/other downloads.

<http://www.denver-electronics.com/denver-cau-438/> Operating Frequency Range:
42MHz-230MHz (VHF) and 474MHz-862MHz(UHF)

Max Output Power: 45W

DENVER ELECTRONICS A/S

Omega 5A, Soeften

DK-8382 Hinnerup

Denmark

www.facebook.com/denverelectronics