

KTC[®] 设计稿、样稿确认

(相同样稿以最新承认日期为准)

物料编号: _____

物料描述: 32D1S Denver 英文 整机说明书(欧洲6683 M2C1) F2006094

(148x210mm 28P)

设计申请人: _____ 设计人: _____

承认人: _____ 承认日期: _____

备注: 封面, 封底, 内页70G双胶纸单黑印刷

贴膜: 7372-2400D1-222002X1
7372-2400D1-122222A1
遥控器: 7601-32P022-0144DNR1
32D1S带底座BCCG-32A

DENVER®

SMART TV with DVB-T2/S2/DVB-C and H.265/HEVC Support

Model: LDS-3278

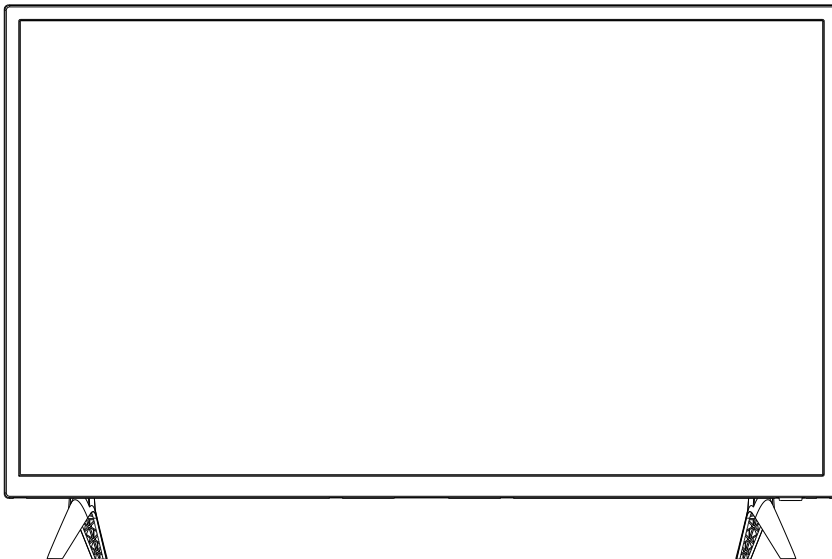

User's Guide

NOTE:

Read all of the instructions before using this TV and keep the instruction manual in a safe place for future reference.

Contents

Safety Information	1-3
Product Introduction	4
Connections	5
Remote Control	6-7
Customizing TV Settings	8-21

Safety Information

IMPORTANT SAFETY INSTRUCTIONS - READ CAREFULLY BEFORE USE.

Take note of the following safety information which appears on the back of the TV.



CAUTION TO PREVENT ELECTRICAL SHOCK, DO NOT REMOVE ANY COVER SCREWS, NO USER SERVICEABLE PARTS INSIDE, REFER SERVICING TO QUALIFIED SERVICE PERSONNEL.



This symbol indicates that there are important operating maintenance instructions in the literature accompanying this unit.



This symbol indicates that dangerous voltage constituting a risk of electric shock is present within this unit.

Keep these instructions

- Do not use this TV near water.
 - Clean only with a slightly damp cloth.
 - Do not block any ventilation openings.
 - Install in accordance with the supplied Quick Start Guide and this User Guide.
 - Protect the power chord from being walked on or pinched, particularly at plugs, and the point where it exits from the TV.
 - Do not allow the power chord to overhang the edge of a table.
 - Unplug this TV during lightening storms or when unused for long periods of time.
-



WARNING! TO REDUCE THE RISK OF FIRE OR ELECTRICAL SHOCK, DO NOT EXPOSE THIS TV TO RAIN OR MOISTURE. THE TV MUST NOT BE EXPOSED TO DRIPPING AND SPLASHING AND NO OBJECTS FILLED WITH LIQUIDS SHOULD BE PLACED ON THE TV.

NOTE: No naked flames such as candles should be placed on the TV.

IMPORTANT SAFETY INFORMATION (Continued)

This unit has been produced according to all current safety regulations. The following safety tips should safeguard users against careless use and the dangers connected with such use.

- Although this appliance has been carefully manufactured and rigorously checked prior leaving the factory, as with all electrical appliances it is possible for problems to develop. If you notice smoke, an excessive build up of heat or any other unexpected phenomena, you should disconnect the plug from the mains power socket immediately.
- Ensure that the unit is sufficiently ventilated! Never place next to or underneath curtains!
- The mains plug or appliance coupler is used as the disconnect device, the disconnect device shall remain readily operable.
- This set should only be connected to a mains power supply which matches that stated on the label on the rear of the TV – do not attempt to connect it to any other type of supply.
- The socket – outlet must be installed near the equipment and easily accessible.
- To prevent overload, don't share the same mains supply socket with too many other items of equipment.
- Apparatus with Class 1 construction shall be connected to a mains socket outlet with a protective earthing connection.
- Keep away from rodents. Rodents enjoy biting into electric flexes.
- Always hold the plug when pulling out the plug from the mains supply socket. Do not pull on the flex, the flex can become overloaded and cause a short circuit.
- Set up the unit so that no one is able to trip over the flex.
- Do not place heavy items on the flex, which may damage it.
- Take note that the flex cannot be reached and pulled by young children, avoiding injury.
- Do not set up the unit near to heat sources. The casing and the flex could be damaged by the impact of heat.
- The screen is made of plastic and can break if damage is done to it. Be careful when collecting sharp edged plastic splinters to avoid injury.
- Avoid placing the unit on any surfaces that may be subject to vibrations or shocks.
- To protect the unit during a thunderstorm unplug the AC power cable and disconnect the aerial. Caution: Do not touch the aerial (RF) connector.
- When you leave your home for long periods of time, unplug the AC power cable for safety reasons.
- The unit becomes warm when in operation. Do not place any covers or blankets on the unit in order to prevent overheating. The ventilation holes are not to be blocked. Do not set up near radiators. Do not place in direct sunshine. When placing on a shelf leave 5 cm (2") free space around the whole unit.
- Do not allow water or moisture to enter the TV. Do NOT use in wet or moist areas such as Bathrooms, steamy kitchens or near swimming pools.
- Do not use this unit when moisture condensation may occur
- Any repairs must be carried out by qualified personnel only.
- Do not open this unit. A non – expert attempting to repair the unit could be dangerous and potentially cause a fire hazard.

Safety Information

IMPORTANT SAFETY INFORMATION (continued)

- Liquids spilt into the unit can cause serious damage. Switch the set OFF and disconnect the mains power supply, then consult a qualified service person before attempting to use the unit again.
- Do NOT remove the safety covers. There are no useable or serviceable parts inside. You may invalidate the warranty. Qualified personnel must only service this apparatus.
- Do NOT tap or shake the screen, you may damage the internal circuits. Take good care of the remote control, do not drop.
- Never place hot objects or open flame sources on or close to the TV.
- High temperatures can melt plastic and lead to fires.
- To clean the TV use a soft dry cloth. Do NOT use solvents or petrol based fluids. For stubborn stains, you may use a damp cloth with dilute detergent.

Headphone Warning

Loud music can damage your hearing irreversibly, therefore do not set the volume to a high level when listening through headphones, particularly for lengthy listening periods.

Where to install

Locate the television away from direct sunlight and strong lights, soft indirect lighting is recommended for comfortable viewing. Use curtains or blinds to prevent direct sunlight falling on the screen. Place the TV on a sturdy platform of which the surface should be flat and steady. This will prevent it from falling over.

Make sure the television is located in a position where it cannot be pushed or hit by objects, as pressure will break or damage the screen, and so that small objects cannot be inserted into the ventilation slots or openings in the cabinet.

Smell/odor from TV

New televisions may produce an unusual smell or odor when first turned on. Due to the manufacturing process of components, televisions and other electronic products can have parts that may produce a smell after the product is first turned on and warms up. The smell will usually dissipate within a few days of use and does not return. This is normal and occurs with many electronic products. Please ensure there is sufficient ventilation around the TV and in the room and the odor will dissipate.

Product Introduction

Front View

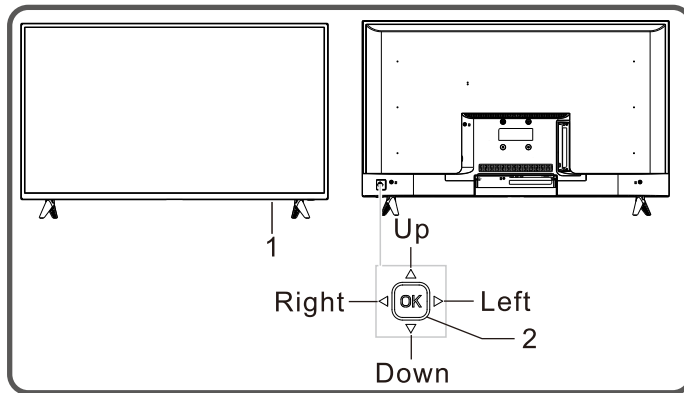

1. Power LED indicator and remote receiving window.
2. Rocker button combination key:

Power on or standby with **OK** rocker:

- ①. When **Plugged** power cord into the electrical socket, you can press **OK** rocker to turn on the TV.
- ②. In power on state, press **OK** rocker to display the function menu, then move rocker **Left/Right** to select **⏻** and press **OK** rocker to switch to standby mode.

After turn on the TV, Press **OK** Rocker:

- ①. In non-OSD menu operation, press **OK** rocker to display the function menu which includes 4 sorts.
- ②. During the menu operation, press **OK** rocker to confirm the operation and the function is the same as **[OK]** key on the remote control.

Move rocker **Left/Right**:

- ①. In non-OSD menu operation, move rocker **Left/Right** to decrease/increase the volume, the function is the same as **[VOL-]/[VOL+]** key on the remote control.
- ②. In OSD menu operation, move rocker **Left/Right** to adjust the analog value of selected item, the function is the same as **[◀]/[▶]** key on the remote control.

Move rocker **Up/Down**:

- ①. In non-OSD menu operation, move rocker **Up/Down** to select the channel, the function is the same as **[CH▲]/[CH▼]** key on the remote control.
- ②. In OSD menu operation, move rocker **Up/Down** to select the adjustment items, the function is the same as **[▲]/[▼]** key on the remote control.

Note: Different models may have different appearances; please refer to the actual device.

Connections

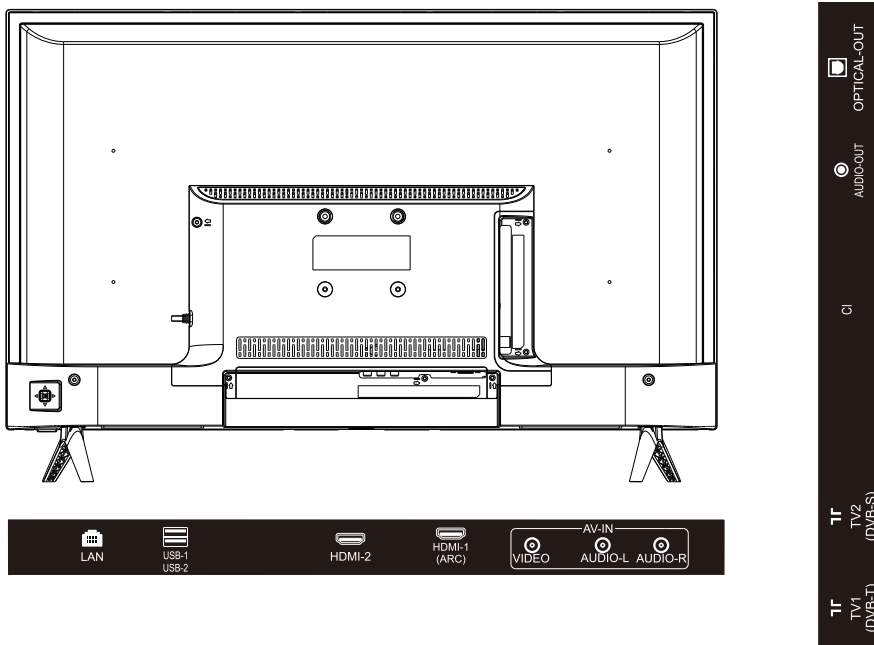

LAN(RJ45): RJ45 plug for connecting to external modem or network access equipment.

HDMI: Connect DVD/Blu-ray player or other equipment.

TV2(DVB-S) :Connect a Satellite signal.

TV1 (DVB-T) :To connect to the aerial socket on the wall with the RF coaxial cable.

Common Interface: CI slot.

AV: Connect it to the audio & video output terminal of DVD .

USB:Connect to USB device for multimedia .

Audio out :connect it to other audio equipment.

OPTICAL-OUT : Connect it to an external digital audio device

Remote Control

The remote control is using Infra-Red(IR). Point it towards the front of the LED TV. The remote control may not work correctly if it is operated out of range or out of angle.



Power : Turn on or turn off the TV (standby mode).

Mute : Mute the sound. Press again to restore the sound.

Number Button : Use with the 0-9 buttons to select digital channels.

LIST : Display or cancel channel list

ASPECT : select a aspect of picture

Youtube : Accesses the "YouTube" online service.

Source : Displays and selects the input source.

Prime Video : Accesses the "Prime Video"online service.

Netflix : Accesses the "Netflix" online service.

Home : Displays or cancel the home page.

Menu : Display or cancel the setting menu.

◀▲▼▶ : To navigate up, down, left or right.

OK : To confirm a selection or setting.

↶ : To switch back to the previous channel you selected.To close a menu without changing a setting.

EXIT : To exit the menu or a smart function. The last selected input source is displayed



Colour keys : The buttons function follow the on-screen instructions.

Info : To open or close programme information.

VOL + - : To adjust the volume level.

CH ^ v : To switch to the next or previous channel in the channel list.

EPG : To open or close the TV Guide.

Audio : To switch the available sound-track in TV mode.

Subtitle: To switch the subtitles on/off, select a subtitle.

TEXT : To open or close Text / Teletext in DTV mode.

SLEEP : To set automatic sleep time.

◀◀ : Previous programme

▶▶ : Next programme

▶ : To playback

|| : To pause playback

■ : To stop playback

Customizing TV Settings

Turning On/Off Your TV

- Connect the power cord to the power socket after you have completed all the physical connections. At this stage, the TV will enter Standby Mode and the red LED indicator will illuminate.
- In Standby Mode, press the **⏻** button on the main unit or on the remote control to turn the TV on. The red LED indicator will turn.



The **POWER** button on the main unit or on the remote control can only switch the TV into standby. To completely turn off the TV, please disconnect the power cord from the power socket.

Initial Setup

LANGUAGE SETTINGS

Confirm your language setting

1

- Deutsch
- ✓ English
- Español
- Français
- Polski
- Português
- Русский

- The first time you turn the TV on, it will go into the Setup Wizard.

Data collection and firmware updates notice

2

End-User License Agreement

- Accept
- ✓ View additional details

COUNTRY SETTINGS

Confirm your country settings

3

- ✓ Germany
- Russia
- Algeria
- Pakistan
- India
- Egypt
- Thailand
- Singapore
- Malaysia

TIMEZONE SETTINGS

Confirm your timezone settings

4

- ✓ Canary GMT
- Lisbon GMT
- Dublin GMT
- London GMT
- Accra GMT
- Amsterdam GMT+1
- Beograd GMT+1
- Berlin GMT+1
- Bratislava GMT+1

Customizing TV Settings

Initial Setup

TV MODE SETTINGS

5

Confirm your TV mode settings

- ✓ Home
- Store

GET CONNECTED

Connect your SmartTV to the internet to enjoy great services like Netflix to watch TV shows and movies.

6

- ✓ Wired
- Wifi
- Skip

PROGRAMME TUNING

Select programme tuning modes

7

- ✓ DVBT
- DVBC
- DVBS
- Skip

- *If channels cannot be found, this frame will be displayed automatically.*

Customizing TV Settings

Source

DTV ATV HDMI1 HDMI2 AV

- Press **SOURCE** on the remote control or on the main unit to display the source menu, then use the **Arrow** buttons to cycle among the different input sources: DTV/ATV/HDMI1 / HDMI2/AV, then use the **Arrow** buttons to highlight the desired source and press **OK** to confirm.

Channel Selection

- Press the **CH[^]/CH^v** buttons on the main unit or on the remote control repeatedly to select the channel.
- Press the **0-9** buttons on the remote control to select the channel directly.



Press "4", and then press **OK** button to select channel 4.
 Press "4" and "5", and then press **OK** button to select channel 45.
 Press "1", "2" and "3", and then press **OK** button to select channel 123.

Volume Adjustment

- Press the **▲ +/-** buttons on the main unit or on the remote control to adjust the volume.
- If you wish to switch the sound off, press the **MUTE** button, and press again or the **VOL+** button to resume the sound.

Customizing TV Settings

Streaming

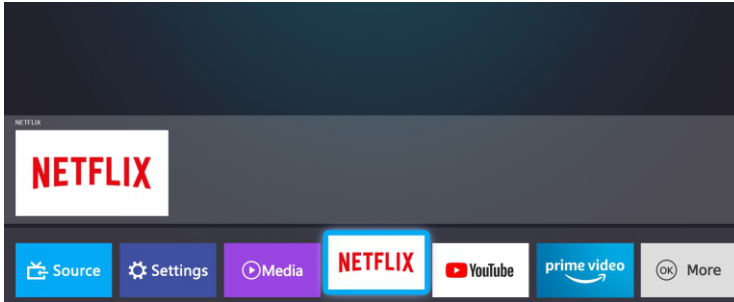

- Press **▲** button on the remote to display the main interface. Then use the Arrow buttons to select **apps** and press **OK** to enter. Use the **Arrow** buttons to select the desired APP and press **OK** button to view. Or press the hotkey on the remote control to enter the desired APP directly.

NETFLIX	Accesses the “Netflix” online service.
YouTube	Accesses the “YouTube”online service.
Prime Video	Accesses the “Prime Video”online service.
Facebook	Facebook is an American online social media and social networking service company based in Menlo Park, California.
Twitter	Twitter is an online news and social networking service on which users post and interact with messages known as “tweets”.
APP STORE	As one of the pioneers of Smart TV, NetRange is the leading global provider of white labeled, turnkey Smart TV and OTT ecosystems.

Customizing TV Settings

Media

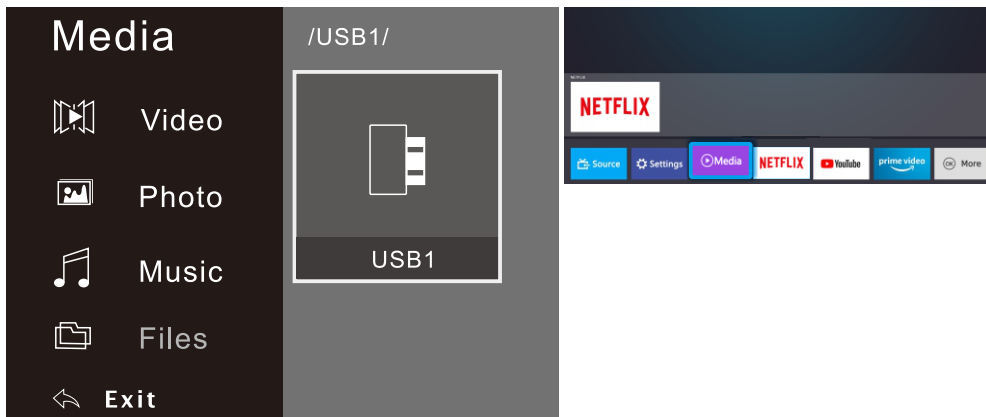

- Press **▲** button to display the main interface, then use the **Arrow** buttons to highlight **MEDIA** and press **OK** to confirm. Select among Photo, Music and Video to view what you like.

Note: Portable drives should be inserted before entering **MEDIA** menu.

Viewing Photos

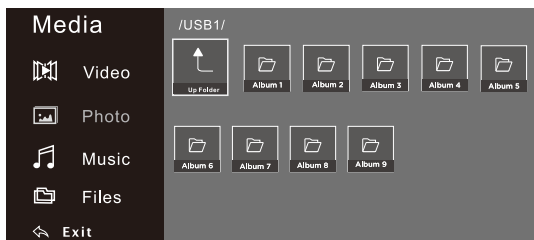

- Use the **Arrow** buttons to highlight the **PHOTO** option and press **OK**, then it will jump to confirm the inserted drive, press **OK** to enter. After entering **PHOTO**, use the **Arrow** buttons to select the picture file and press **OK** to enter.

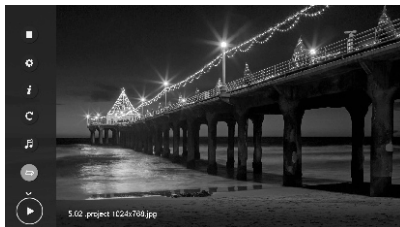

- After entering the picture file, use the **Arrow** buttons to select the desired picture, then press the **▶** to display. When the picture is playing, the picture Function Bar will be displayed. Use the **Arrow** buttons to select the desired function available on the bar.

Customizing TV Settings

Listening To Music

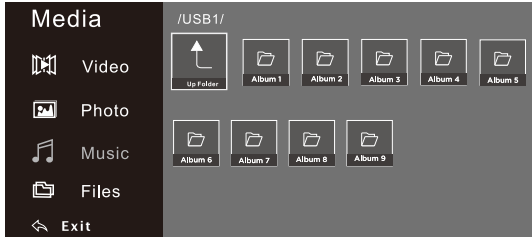

- Use the **Arrow** buttons to highlight the **MUSIC** option and press **OK**, then it will jump to confirm the inserted drive, press **OK** to enter. After entering **MUSIC**, use the **Arrow** buttons to select the audio file and press **OK** to enter.

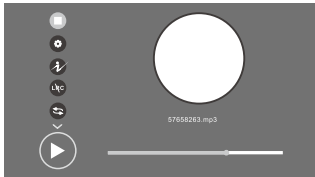

- After entering the audio file, use the **Arrow** buttons to select the desired music, then press the **▶** to display. When the music is playing, the music Function Bar will be displayed. Use the **Arrow** buttons to select the desired function available on the bar.

Watching Videos

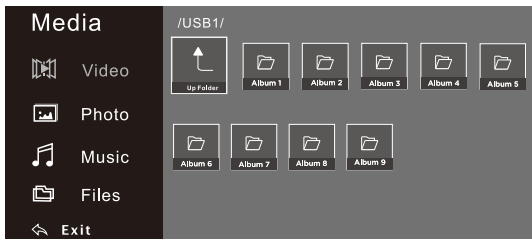

- Use the **Arrow** buttons to highlight the **VIDEO** option and press **OK**, then it will jump to confirm the inserted drive, press **OK** to enter. After entering **VIDEO**, use the **Arrow** buttons to select the video file and press **OK** to enter.



- After entering the video file, use the **Arrow** buttons to select the desire video, then press the **▶** to display. When the video is playing, the video function bar will be displayed. Use the **Arrow** buttons to select the desired function available on the bar.

Customizing TV Settings

TV Settings

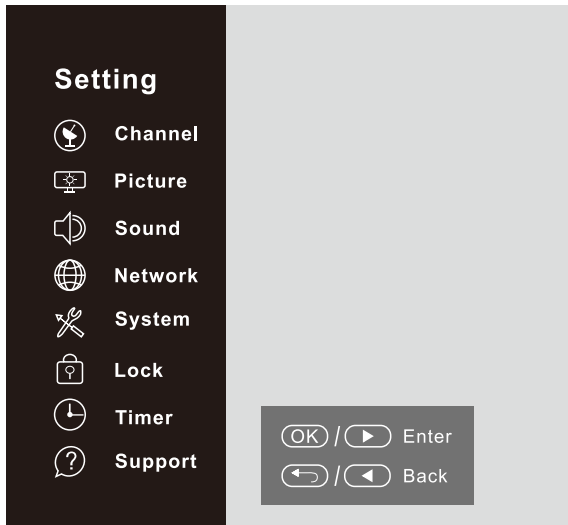

- Press the  button on the main unit or on the remote control to display the main Setting . Then use the **Arrow** buttons to highlight **TV Settings** and press **OK** to enter. Then use the **Arrow** buttons to cycle among the following options and select the desired one to enter.

Customizing TV Settings

General

System Setting/	
Language	English
Subtitle	Off
Subtitle Hearing Impaired	Off
Audio Language	
Subtitle Language	
HBBTV	On
Country	Germany
WOW	Off
HDMI_CEC	On
Environment	HOME
Restore Factory Default Settings	

- Press  to display the main Setting , then use the **Arrow** buttons to highlight **TV Settings** and press **OK** to confirm. Use the **Arrow** buttons to cycle among different options and select **System** to enter and adjust each option setting.

Language	Select your preferred On Screen Display language.
Subtitle	Switch the Subtitle function on or off.
Subtitle Hearing Impaired	When hearing Impaired is ON, the TV screen will give some information to the people whose hearing are impaired.
Audio Language	Select your preferred audio language. (Available for digital channels if multiple audio languages are broadcasted.)
Subtitle Language	Select your preferred subtitle Language.(Available for digital channels if multiple subtitle languages are broadcasted.)
HBBTV	Switch the HBBTV function On or Off.
Country	Select your country
WOW	WOW allows remote systems to wake up the sleeping TV by sending a frame of a specific format which the client anticipates.
HDMI-CEC	The HDMI CEC system can be used only with devices that have the HDMI CEC feature. You must connect an HDMI CEC device using an HDMI cable.
Environment	You can select Home or Store for the TV environment . It is recommended to set the TV to Home Mode.
Restore Factory Default Settings	Restore the system setting to the factory default . When the restore is complete , the TV will enter standby mode.

Customizing TV Settings

Picture Settings

Picture Setting/	
Picture Mode	Standard
Color Temperature	Nature
Aspect Ratio	Auto
Noise Reduction	Middle

- Press **■** to display the main setting, then use the **Arrow** buttons to highlight **TV Settings** and press **OK** to confirm. Use the **Arrow** buttons to cycle among different options and select **Picture** to enter and adjust each option setting.

Picture Mode	Select the type of picture which best corresponds to your viewing requirements. More detailed parameters can be adjusted when the picture mode is set to User.
Color Temperature	Select the color temperature of the picture.
Aspect Ratio	You can select the picture size which best corresponds to your viewing requirements.
Noise Reduction	Reduces screen noise without compromising video quality.

Customizing TV Settings

Audio Settings

Sound	
Setting/	
Sound Mode	Standard
Surround Sound	Off
SPDIF Mode	PCM
AD Switch	Off
AD Volume	35
Audio Type	Normal
Audio Delay	

- Press  to display the main setting, then use the **Arrow** buttons to highlight **TV Settings** and press **OK** to confirm. Use the **Arrow** buttons to cycle among different options and select **Sound** to enter and adjust each option setting.

Sound Mode	You can select a sound mode to suit your personal preferences. Five-stage equalization sound can be adjusted when the sound mode is set to User.
Surround Sound	Switch the Surround Sound function On or Off..
SPDIF Mode	SPDIF provides digital audio output to speakers and various digital devices such as A/V Receivers and Home Theaters.
AD Switch	This is an auxiliary audio function which handles the Audio Stream for the AD (Audio Description), when it is sent along with the Main audio from the broadcaster.
AD Volume	The AD Volume can be adjusted here.
Audio Type	You can set the audio mode type.
Audio Delay	Correct audio-video sync problems, when watching DTV and when listening to digital audio output using an external device such as an audio receiver (0ms-250ms).

Network Settings

Network	
Setting/	
MAC:f4:ed:5f:41:31:1c	
Connection Type	Wired
IPv4	Auto
⊗ Connection Fail	

- Press  to display the main setting, use the Arrow buttons to highlight TV SETTINGS and press OK to confirm. Then Use the Arrow buttons to select **Network** to enter and adjust each option setting.

Connection Type	You can set up your TV so that it can access the Internet through your local area network (LAN) using a wired or wireless connection.
IPv4	Wired network config of IPv4, to set the IP Address, Subnet Mask, Gateway and DNS manually or automatically.

Customizing TV Settings

Channel Settings

Channel Setting/		<ul style="list-style-type: none"> Press  to display the main setting , then use the Arrow buttons to highlight TV Settings. Use the Arrow buttons to cycle among different options and select Channel to enter and adjust each option setting. 	
Antenna Type	DVBT	Antenna Type	Selecting an antenna source.
Auto Tuning		Auto Tuning	Press [OK] button then select search to start Auto Tuning. The TV will begin memorizing all of the available channels.
DTV Manual Tuning		DTV Manual Tuning	Manual store for digital channels. When a channel is found, the channel will be saved with current channel number.
ATV Manual Tuning		ATV Manual Tuning	Manual store for ATV channels.
Programme Edit		Programme Edit	Channallist for Edit including skip and set favorite channel.
Signal Information		Signal Information	Display the current Signal information.
Software Update (OAD)	On	Software Update (OAD)	You can set the switch for OAD upgrade , when the system needs to be upgraded through OAD , it needs to be set to on.

Customizing TV Settings

Time Settings

Timer	
Setting/	
Auto Sync.	On
Time Zone	Berlin GMT+1
Clock	19:47
Sleep Timer	Off
OSD Time	15 Seconds
Auto Sleep	2 Hours
No Signal Power Off	On

- Press  to display the main setting, then use the **Arrow** buttons to highlight **TV Settings** and press **OK** to confirm. Use the **Arrow** buttons to cycle among different options and select **Timer** to enter and adjust each option setting.

Auto Sync.	If set it to On, the TV will sync the local clock according to the DTV broadcasting time automatically.
Time Zone	Select your time zone.
Clock	Set the TV clock manually.
Sleep Timer	Sleep Timer switches the TV to standby after a defined period of time. To cancel the Sleep Timer, set to Off.
OSD Time	OSD time setting menu disappears time. To cancel the OSD time, set to Always.
Auto Sleep	Select the Auto Sleep time as you want , The TV will enter into standby mode automatically when there is no operation in set time.
No Signal Power Off	When set to On, if there's no TV signal nor press-button operation ,the TV will enter standby status automatically about 5 minutes later.

Customizing TV Settings

Lock Settings

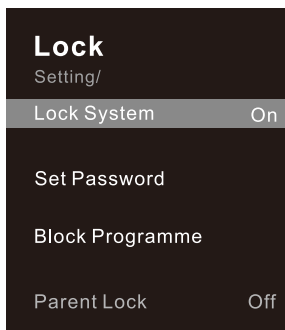

- Press to display the main setting , then use the **Arrow** buttons to highlight **TV Settings**. Use the **Arrow** buttons to cycle among different options and select **Lock** to enter and adjust each option setting.

Note: the default password is “0000”.

Lock System	4-dight password can prevent unauthorized access of this TV set.
Set Password	You can set your private password. Press the number buttons on the remote control to set the new password.
Block Programme	Press the yellow button to lock or unlock the available program as you want.
Parent Lock	Set Content Rating limit & prevent your kids from watching any such programmes

Customizing TV Settings

Motion Picture Association of America (MPAA) Rating System

	Grade	Meaning
G	General Audiences	Content not offensive to most viewers.
PG	Parental Guidance Suggested	Content is such that parents may not want their children to view the program.
PG-13	Parents Strongly Cautioned	Program is inappropriate for pre-teens, with a greater degree of offensive material suggested than a PG rated program.
R	Restricted	Not for children under 17, strong element of sex and/or violence.
NC-17	No children under age 17	Not for children under 17 under any circumstances. Strong sexual content.
X	Hard Core Films	Same as NC-17 rating.
No Rating	No Rating	MPAA Not Rated

TV Parental Guideline Rating System

	Grade	Meaning
TV-Y	All Children	Content not offensive to most viewers.
TV-Y7	Directed to Older Children	Considered suitable for children over 7, may contain fantasy violence scenes.
TV-G	General Audience	Considered suitable for all audience; children may watch unattended.
TV-PG	Parental Guidance Suggested	Suggested unsuitable for younger children, may contain suggestive language, bad language, sex and violence scenes.
TV-14	Parents Strongly Cautioned	unsuitable for children under 14, may contain strong language, bad language, sex and violence scenes.
TV-MA	Mature Audience Only	Adults only, may contain strong language, bad language, sex and violence scenes.

Canadian Rating:

- Canadian English is used throughout all English-speaking Canada (C, C8+,G, PG,14+, 18+).
- Canadian French is used in Quebec (G,8 ans+, 13 ans+,16 ans+, 18 ans+).



The V-Chip will automatically block certain categories that are "more restrictive". If you block TV-Y category, then TV-Y7 will be automatically blocked. Similarly, if you block TV-G category, then all the categories in the "young adult" will be blocked (TV-G, TV-PG, TV-14, and TV-MA).

ALL RIGHTS RESERVED, COPYRIGHT DENVER ELECTRONICS A/S

DENVER®

www.denver-electronics.com



Electric and electronic equipment and included batteries contains materials, components and substances that can be hazardous to your health and the environment, if the waste material (discarded electric and electronic equipment and batteries) is not handled correctly.

Electric and electronic equipment and batteries is marked with the crossed out trash can symbol, seen below. This symbol signifies that electric and electronic equipment and batteries should not be disposed of with other household waste, but should be disposed of separately.

As the end user it is important that you submit your used batteries to the appropriate and designated facility. In this manner you make sure that the batteries are recycled in accordance with legislature and will not harm the environment.

All cities have established collection points, where electric and electronic equipment and batteries can either be submitted free of charge at recycling stations and other collection sites, or be collected from the households. Additional information is available at the technical department of your city.

Please enter: www.denver-electronics.com and then click the search ICON on topline of website.

Write modelnumber: LDS-3278.

Now enter product page, and red directive is found under downloads/other downloads.

Operating Frequency Range: (VHF)174~230MHz ; (UHF)474~862MHz.

Max Output Power: 55 W

DENVER ELECTRONICS A/S

Omega 5A, Soeften

DK-8382 Hinnerup

Denmark

www.facebook.com/denverelectronics



 **ENERG** Y IJA
енергия · ενεργεια IE IA

DENVER[®] LDS-3278

A+++
A++
A+
A
B
C
D

A

ENERGIA · ЕНЕРГИЯ
ΕΝΕΡΓΕΙΑ · ENERGIJA
ENERGY · ENERGIE
ENERGI

 **32**
Watt

47
kWh/annum

80
cm  **32**
inch

2010/1062 - 2020

