



DENVER[®]

DENVER HSM-5003

Surveillance kamera

Quick Start Guide

Overview

- | | |
|--------------------------------|---------------------|
| 1) Bottom Cover | 2) microSD Slot |
| 3) USB Connector | 4) TV Out connector |
| 5) PIR | 6) Infrared Flash |
| 7) Lens | 8) GSM Antenna |
| 9) 2 inch color LCD Display | |
| 10) Sound recorder | |
| 11) SIM card slot | |
| 12) Lock | |
| 13) Power switch | |
| 14) Battery Depot | |
| 15) Portable remote controller | |

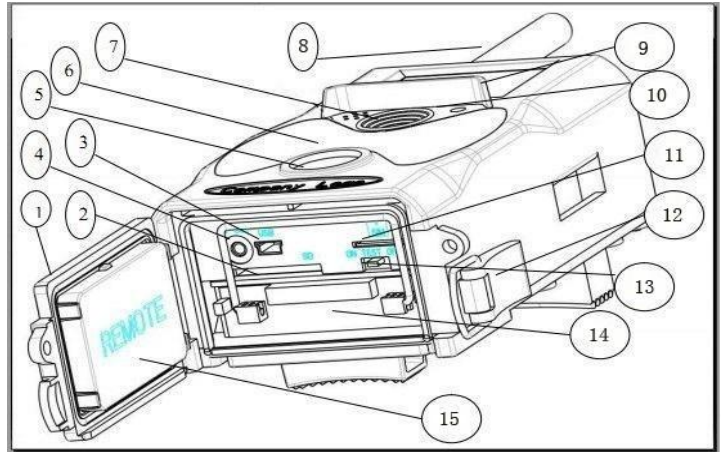

The camera has 3 basic operation modes:

1. OFF mode: Power switch is at OFF position.
2. ON mode: Power switch is at ON position.
3. TEST mode: Power switch is at TEST position.

In the above three modes, the OFF mode is the specified safe mode when replacing the microSD or batteries and transporting the camera.

A. There are 3 modes under system setting for your selection.

a. Camera

It only takes photos at a time.

b. it only takes videos at a time.

c. Camera & Video.

It takes photo firstly, then takes videos.

B. There are also 2 ways to take photos or videos.

a. Manually by using the remote control

After sliding power switch to 'TEST', without any menu on the screen, press Shot(Right) on the remote control to take photos or videos.

b. Automatically

After sliding power switch to ON, the LED blinks 15s, then the camera takes photos or videos when the movement is detected.

C. To view the photos of videos on the camera, please turn off the camera, slide power switch to Test, press OK key on remote control to enter view model.

a. Photos

Press up or down on the remote control to view the previous of next photo.

b. Videos

Press left button on the remote control to start the video, press left button again to stop. Note: Press OK to return to screen.

D. Please note, that this is not an error with the Camera:

Heavy rain, fog and drizzle (in the dark) will give white photos without motive.

E. Sending image via 2G/GSM/MMS/GPRS

Preparation

1. 2G/GSM Mobile Operator Service.
2. Format 2GB+ microSD card.
3. Computer(Vista, Windows 7, windows 8 system).
4. One SIM card without PIN lock
5. The SIM card should be able to send images via 2G/GSM/ GPRS/MMS network.
6. 6V power (4 or 8 AA Batteries, or 6V input power supply).
7. MMSCONFIG Program in CD.
8. Users need to ask the provider 2G MMS data (APN+account+password, MMSC+IP+PORT) or find this info on providers homepage.
9. 2G GPRS data for SMTP setting from provider (APN+account+password).
10. Sender Email server info (server+port+email+password).

MMS Setting Steps





1. Insert microSD card and SIM to camera, put batteries in cam, screw antenna to it then turn camera to test mode, check there are signal bar and "SIM" on the camera screen. Then connect the camera to the PC with the

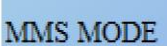

included USB cable. insert CD to computer, open and then double click  MMSCONFIG

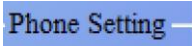
2. Choose  Mode  Camera or  Mode  Camera & Video in  Menu Go to

 MMS table, select  MMS MODE  Manual

3. Insert  Gprs Setting and  Server Setting

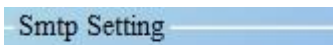
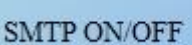
4. Fill in  Phone Setting and or  Email Setting
 Phone1  Email1

5. Go to  SMTP, choose  Smtip Setting
 SMTP ON/OFF  OFF

6. Click  Save button and save as Parameter.dat to microSD card.

7. Plug USB cable from camera.



8. Go to  in camera menu, check the subsetting is the same with above setting.



9. Turn camera to on mode.

GPRS Setting Steps

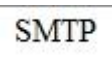

1. Insert microSD card and SIM to camera, put batteries in cam, screw antenna to it then turn camera to test mode, check there are signal bar and "SIM" on the camera screen. Then connect the camera to the PC with the included USB cable.

Insert CD to computer, open and then double click  .

2. Choose  Camera or  Camera & Video

Go to  table, select  Manual

3. Insert all 

4. Fill in sender email info in  and 

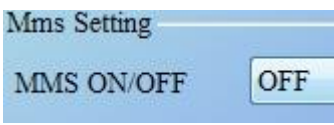
5. Go to  table, choose 

6. Click  button and save as `parameter.dat` to microSD card.

7. Plug USB cable from camera.

8. Go to  in cam menu, check the subsetting is the same with above setting.

9. Turn camera to on mode.

F. SMS Command List

MMS/SMTP need to be set 'on' mode before using these sms command

1 *500* take picture

(can work in both mms and smtp mode)

SIM in camera will send Capture when receive *500* command

2. *505* take picture and send to the mobile who sends sms

sim in camera will send Start capturing.. and still send picture to inserted Mobile ID and/or email when got *505* Command, no matter MMS or smtp mode.

But sim will send images via MMS to the mobile who sends SMS when camera only in MMS mode

3.*520* check the picture quantity and battery status

(can work in both MMS and SMTP mode)

SIM will send Total Jpg: Free Space: Battery Level: when receive *520* command

4. *530* turn on sensor

(can work in both MMS and SMTP mode)

SIM will send Start OK when receive *530* command

5. *531* turn sensor to sleeping mode

(can work in both MMS and SMTP mode)

SIM will send Stop OK when receive *531* command

ALL RIGHTS RESERVED, COPYRIGHT DENVER ELECTRONICS A/S

DENVER®

www.denver-electronics.com



Electric and electronic equipment and included batteries contains materials, components and substances that can be hazardous to your health and the environment, if the waste material (discarded electric and electronic equipment and batteries) is not handled correctly.

Electric and electronic equipment and batteries is marked with the crossed out trash can symbol, seen below. This symbol signifies that electric and electronic equipment and batteries should not be disposed of with other household waste, but should be disposed of separately.

As the end user it is important that you submit your used batteries to the appropriate and designated facility. In this manner you make sure that the batteries are recycled in accordance with legislature and will not harm the environment.

All cities have established collection points, where electric and electronic equipment and batteries can either be submitted free of charge at recycling stations and other collection sites, or be collected from the households. Additional information is available at the technical department of your city.

Hereby, Inter Sales A/S declares that the radio equipment type HSM-5003 is in compliance with Directive 2014/53/EU. The full text of the EU declaration of conformity is available at the following internet address: <http://www.denver-electronics.com/denver-HSM-5003/>

Operating Frequency Range: 850-1900MHz

Max Output Power: 2W

Imported by:

DENVER ELECTRONICS A/S

Omega 5A, Soeften

8382 Hinnerup

Denmark

[facebook.com/denverelectronics](https://www.facebook.com/denverelectronics)